

Panasonic

Plain Paper FAX
with 900 MHz Cordless Phone

Model No.

KX-FPC135

Quick Start



To get started,
please read the
Quick Start section
(p. 5 - 11).

OPERATING INSTRUCTIONS

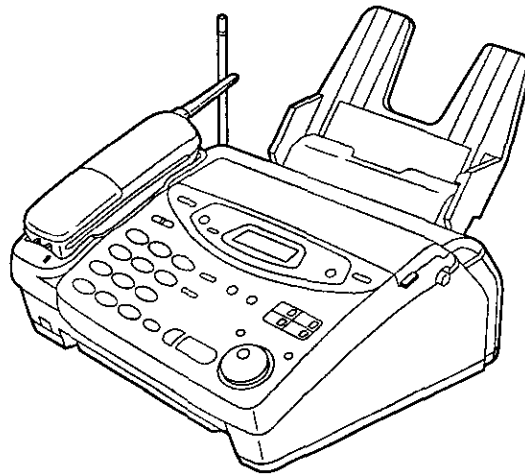

Please read these Operating Instructions before using the unit and save for future reference.

**FOR OPERATION ASSISTANCE,
CALL 1-800-HELP-FAX (1-800-435-7329)
OR SEND A FAX TO 1-215-741-6376.**

- This unit is designed for use in the United States of America, and may not operate in other countries. (See page 115 for more details.)
- Este producto ha sido diseñado para su uso en los Estados Unidos de América, y puede no funcionar correctamente en otros países. (Consulte la página 115 para tener más detalles.)

Comienzo rápido (p. 116)

Initial Preparation

Telephone

Fax/Copy

Help

General Information

Comienzo rápido
en español

Thank you for purchasing a Panasonic facsimile.

Welcome to the world of Panasonic facsimiles.

This product combines facsimile, telephone and copier features to provide you with more efficient office or home use. By utilizing these convenient features, you can maximize the effectiveness of this unit.

Things you should keep record of

Attach your sales receipt here

For future reference

Date of purchase

Serial number

(found on the rear of the unit)

Dealer's name and address

Dealer's telephone number

Caution:

- The Telephone Protection Act of 1991 requires the following information to be clearly stated either at the top or bottom margin of the first message page when transmitting messages via telephone facsimile;
 - Date and time of transmission,
 - Identification of the business, entity or person(s) sending the facsimile, and
 - Telephone number of the business, entity or person(s).To program this information into your unit, complete all the instructions on pages 25 to 28.
- Note that the images of copied or received documents will remain on the used film. Use discretion when disposing of the used film cartridge.
- Do not rub or use an eraser on the printed side, as the print may smear.
- If you have not applied to the *faxSÄV*[®] service, you will not be able to use the IQ-FAX function (p. 56–58).

Trademarks

faxSÄV is a registered trademark of FaxSav Incorporated.

Hammermill is a registered trademark of INTERNATIONAL PAPER in the United States and/or other countries. All other trademarks identified herein are the property of their respective owners.

Copyright:

This manual is copyrighted by Kyushu Matsushita Electric Co., Ltd. (KME) and its licensee. Under the copyright laws, this manual may not be reproduced in any form, in whole or part, without the prior written consent of KME and its licensee.

© Kyushu Matsushita Electric Co., Ltd. 1999

For best performance

Battery charge

To power the handset, charge for about **4 hours** before initial use (p. 30).

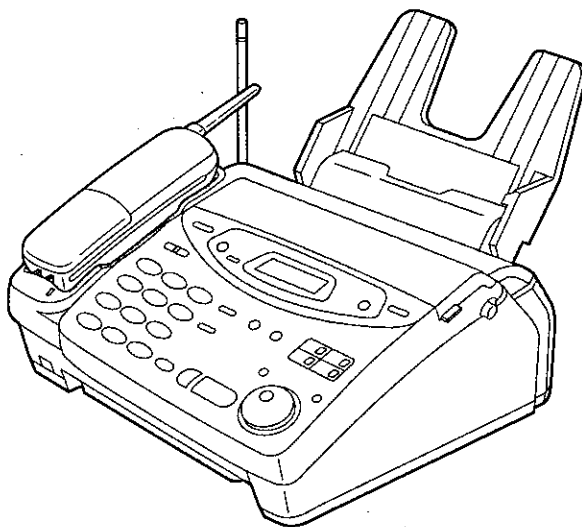

Operating distance and noise

Calls are transmitted between the main unit and the handset using wireless radio waves. **For maximum distance and noise free operation**, the recommended main unit location is:

Away from electrical appliances such as TVs, radios, or personal computers.

In a **HIGH** and **CENTRAL** location with no obstructions such as walls.

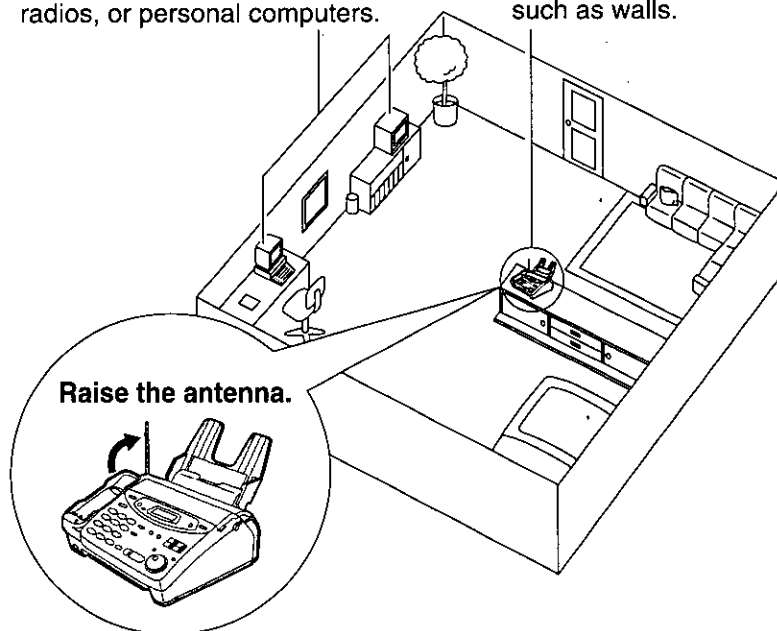

Raise the antenna.

Important safety instructions

When using this unit, basic safety precautions should always be followed to reduce the risk of fire, electric shock, or personal injury.

1. Read and understand all instructions.
2. Follow all warnings and instructions marked on this unit.
3. Unplug this unit from AC outlets before cleaning. Do not use liquid or aerosol cleaners. Use a damp cloth for cleaning.
4. Do not use this unit near water, for example near a bath tub, wash bowl, kitchen sink, or the like.
5. Place the unit securely on a stable surface. Serious damage and/or injury may result if the unit falls.
6. Do not cover slots and openings on the unit. They are provided for ventilation and protection against overheating. Never place the unit near radiators, or in a place where proper ventilation is not provided.
7. Use only the power source marked on the unit. If you are not sure of the type of power supplied to your home, consult your dealer or local power company.
8. For safety purposes this unit is equipped with a three prong grounded plug. If you do not have this type of outlet, please have one installed. Do not use any type of adaptor plug to defeat this safety feature.
9. Do not place objects on the power cord. Install the unit where no one can step or trip on the cord.
10. Do not overload wall outlets and extension cords. This can result in the risk of fire or electric shock.
11. Never push any objects through slots in this unit. This may result in the risk of fire or electric shock. Never spill any liquid on the unit.
12. To reduce the risk of electric shock, do not disassemble this unit. Take the unit to an authorized servicenter when service is required. Opening or removing covers may expose you to dangerous voltages or other risks. Incorrect reassembly can cause electric shock when the unit is subsequently used.
13. Unplug this unit from the wall outlet and refer servicing to an authorized servicenter when the following conditions occur:
 - A. When the power supply cord or plug is damaged or frayed.
 - B. If liquid has been spilled into the unit.
 - C. If the unit has been exposed to rain or water.
 - D. If the unit does not work normally by following the operating instructions. Adjust only controls covered by the operating instructions. Improper adjustment may require extensive work by an authorized servicenter.
 - E. If the unit has been dropped or physically damaged.

F. If the unit exhibits a distinct change in performance.

14. During thunderstorms, avoid using telephones except cordless types. There may be a remote risk of an electric shock from lightning.
15. Do not use this unit to report a gas leak, when in the vicinity of the leak.

CAUTION:

To reduce the risk of fire or injury to persons, read and follow these instructions.

1. Use only the battery(ies) specified.
2. Do not dispose of the battery(ies) in a fire. They may explode. Check with local waste management codes for special disposal instructions.
3. Do not open or mutilate the battery(ies). Released electrolyte is corrosive and may cause burns or injury to the eyes or skin. The electrolyte may be toxic if swallowed.
4. Exercise care in handling batteries in order not to short the battery to conductive materials such as rings, bracelets, and keys. The battery and/or conductor may overheat and cause burns.
5. Charge the battery(ies) provided with or identified for use with this product only in accordance with the instructions and limitations specified in this manual.

INSTALLATION:

1. Never install telephone wiring during a lightning storm.
2. Never install telephone jacks in wet locations unless the jack is specifically designed for wet locations.
3. Never touch uninsulated telephone wires or terminals unless the telephone line has been disconnected at the network interface.
4. Use caution when installing or modifying telephone lines.

WARNING:

- To prevent the risk of fire or electrical shock, do not expose this product to rain or any type of moisture.

OTHER INFORMATION:

- Keep the unit away from electrical noise generating devices, such as fluorescent lamps and motors.
- The unit should be kept free from dust, high temperature and vibration.
- The unit should not be exposed to direct sunlight.
- Do not place heavy objects on top of this unit.
- Do not touch the plug with wet hands.

SAVE THESE INSTRUCTIONS

Installation

Before installation (p. 20)

A. Remove the shipping tape.

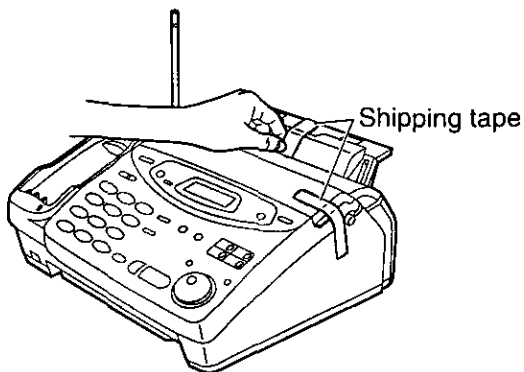

B. Open the cover, remove the leaflet under the film cartridge and close the cover.

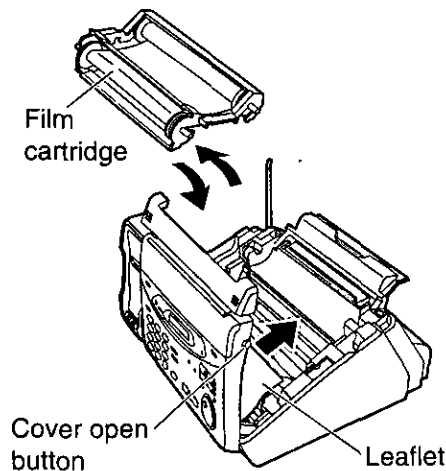

1 Paper tray (p. 21)

Insert the two tabs on the paper tray into the slots on the back of the unit.

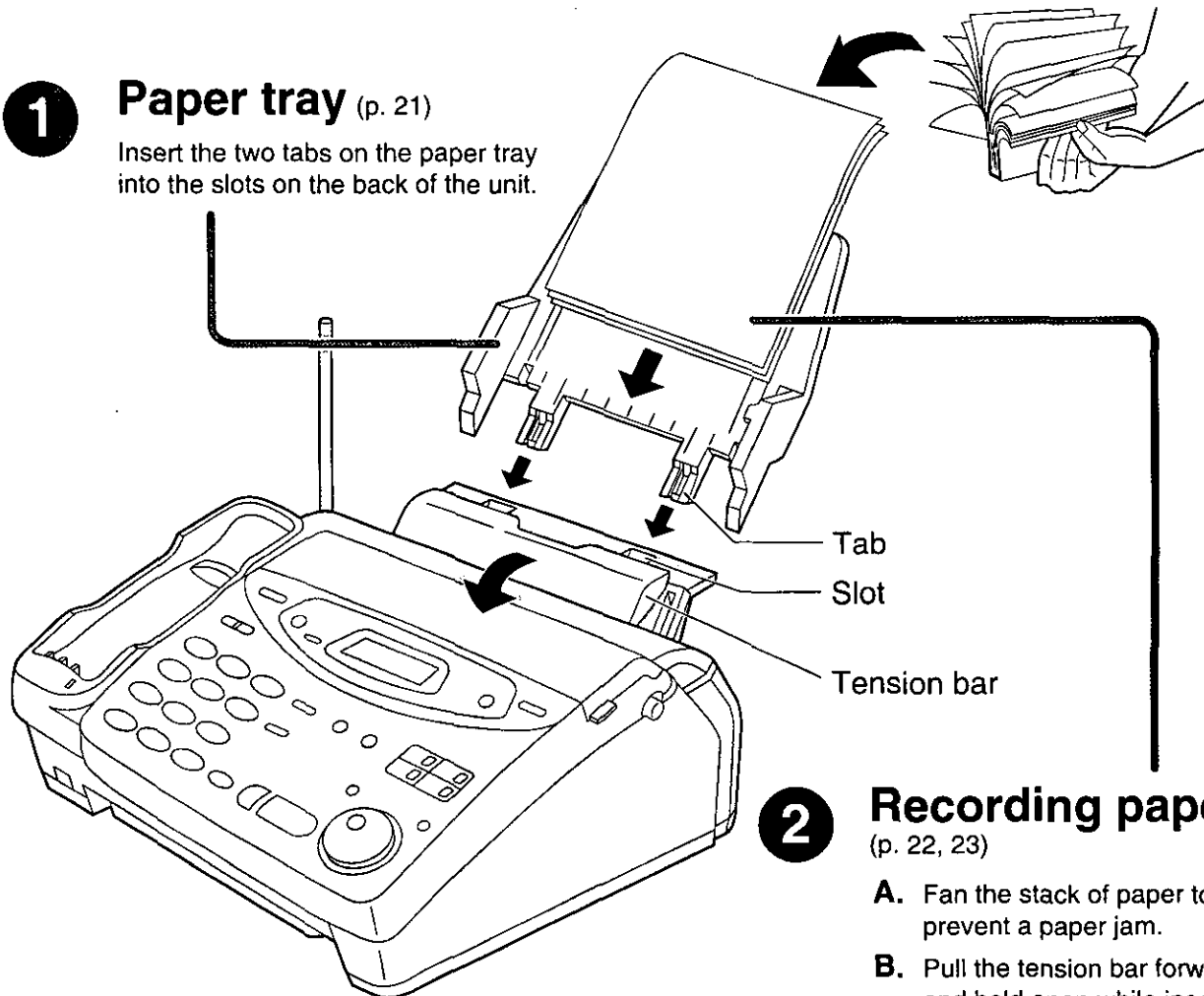

2 Recording paper (p. 22, 23)

A. Fan the stack of paper to prevent a paper jam.

B. Pull the tension bar forward and hold open while inserting the paper.

Connections

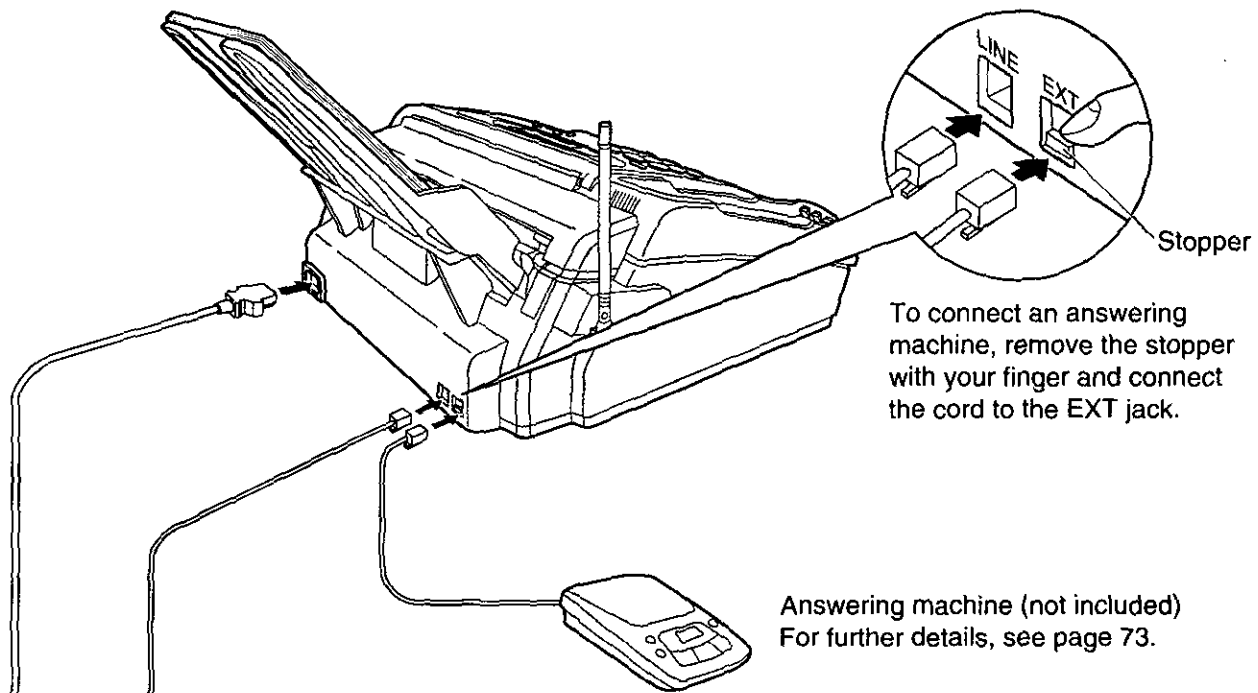

1 Telephone line cord

- A. Connect to "LINE" on the unit.
- B. Connect to a single telephone line jack.

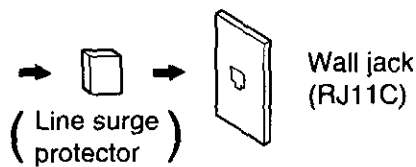

2 Power cord

- A. Connect to the unit.
- B. Connect to a power outlet.

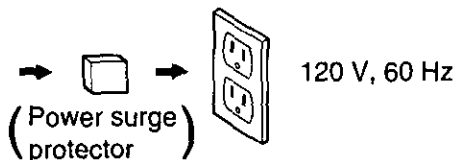

● For further details, see page 24.

Voice calls - making

- 1** Press **TALK**.
- 2** Dial the number.
- 3** When finished talking, press **TALK**.

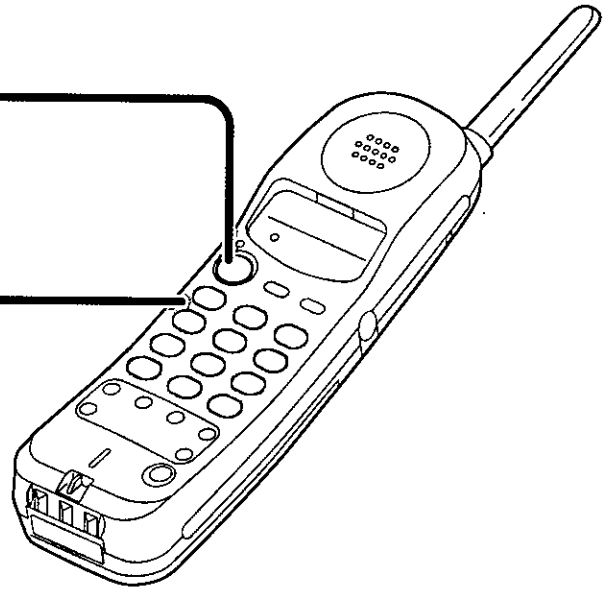

- For further details, see page 33.
- If you are having trouble, see pages 93 and 94.

Voice calls - answering

■ Handset is off the main unit

1 When the handset rings, press **TALK**.

2 When finished talking, press **TALK**.

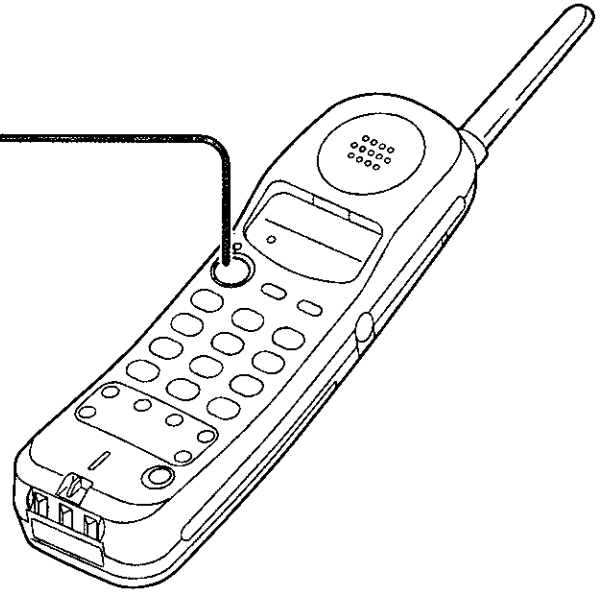

- For further details, see page 35.
- If you are having trouble, see pages 93 and 94.

■ Handset is on the main unit

1 When the unit rings, lift the handset.

2 When finished talking, replace the handset.

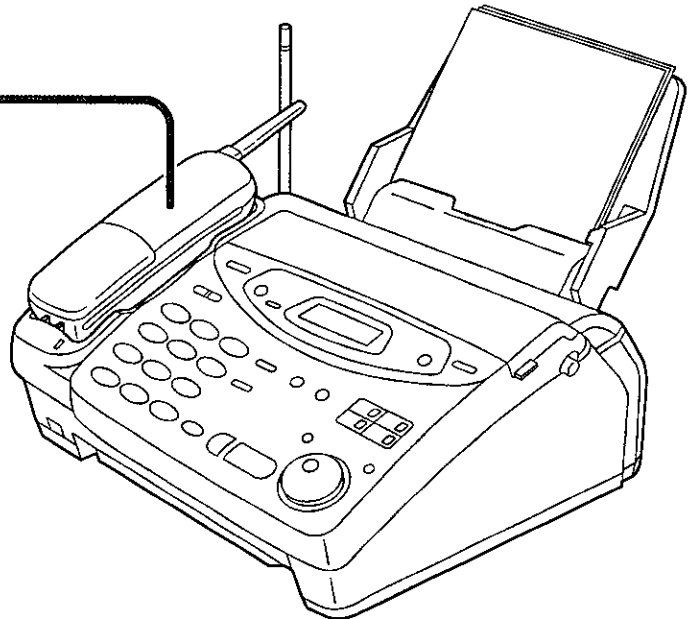

- For further details, see page 35.
- If you are having trouble, see pages 93 and 94.

Faxes - sending/receiving

Faxes - sending

- 1 Open the document feeder tray.

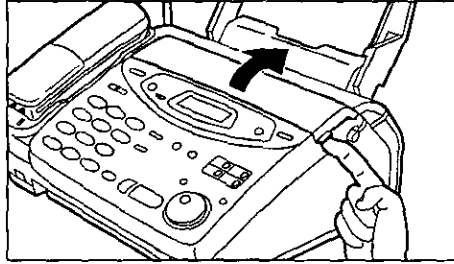

- 2 Adjust the width of the document guides to the size of the document.

- 3 Insert the document until a single beep is heard and the unit grabs the document.

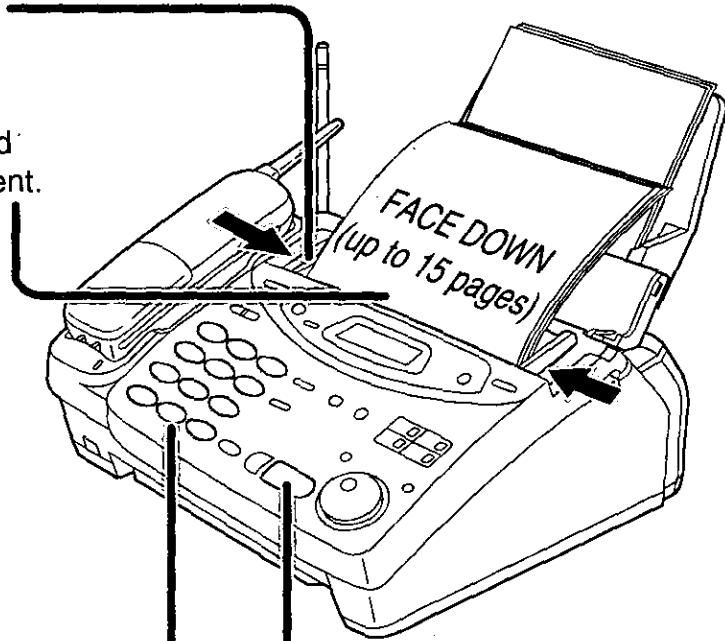

- 4 Dial the fax number.
- 5 Press **START/SET/COPY**.

- For further details, see page 53.
- If you are having trouble, see pages 93 and 95.

Faxes - receiving

■ Handset is off the main unit

1 When the handset rings, press **TALK**.

2 When:
— document reception is required,
— a fax calling tone (slow beep) is heard, or
— no sound is heard,
press **FAX** until a single beep is heard.

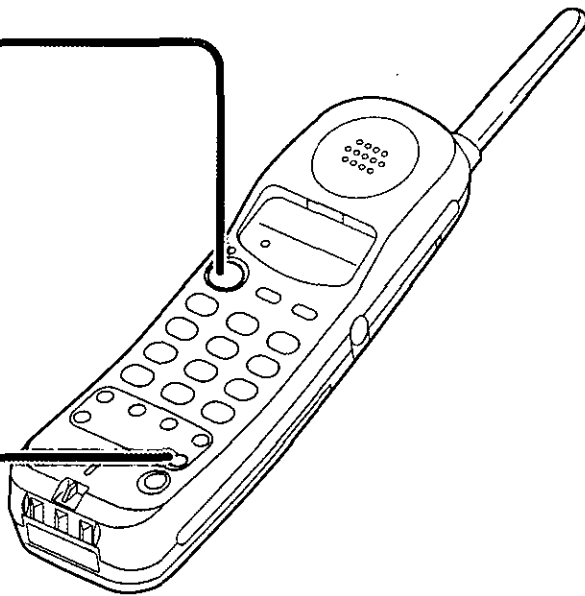

- For further details, see page 70.
- You can select the way to receive calls according to your needs (p. 68, 69).
- If you are having trouble, see page 95.

■ Handset is on the main unit

1 When the unit rings, lift the handset.

2 When:
— document reception is required,
— a fax calling tone (slow beep) is heard, or
— no sound is heard,
press **START/SET/COPY**.

3 Replace the handset.

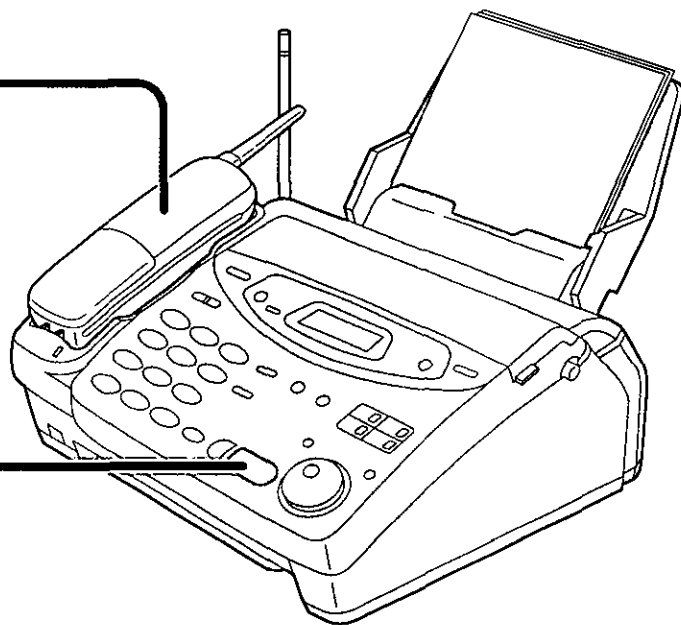

- For further details, see page 70.
- You can select the way to receive calls according to your needs (p. 68, 69).
- If you are having trouble, see page 96.

Copying

- 1 Open the document feeder tray.

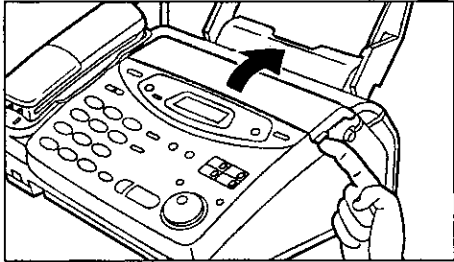

- 2 Adjust the width of the document guides to the size of the document.

- 3 Insert the document until a single beep is heard and the unit grabs the document.

- 4 Press **START/SET/COPY**.

- 5 Enter the number of copies.

- 6 Press **START/SET/COPY**.

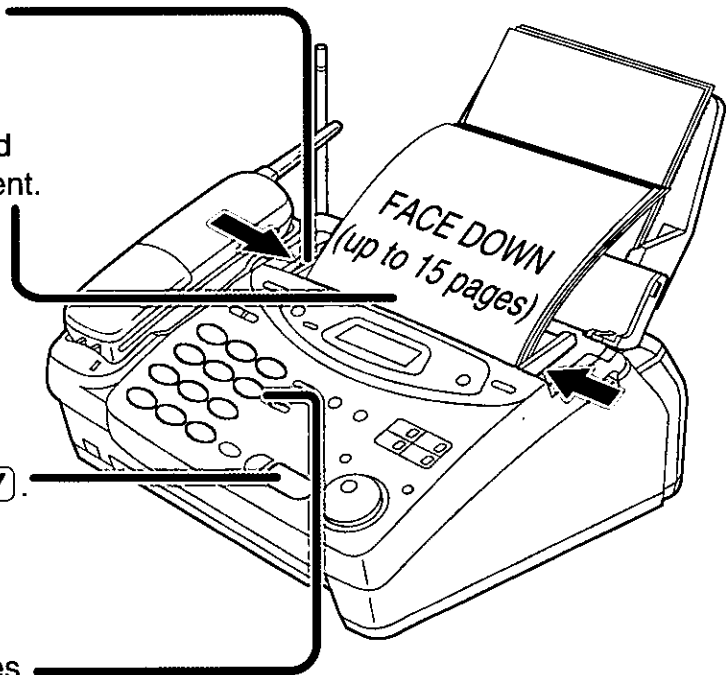

- After step 4, if you do not make any operations within 15 seconds of each other, the unit will start copying automatically.
- For further details, see page 88.
- If you are having trouble, see page 96.

Table of Contents

Initial Preparation	Accessories	Included accessories	15
		Accessory order information	16
	Help Button	Help function	17
	Finding the Controls (Main Unit)	Location	18
		Overview	20
	Setup (Main Unit)	Before installation	20
		Paper tray	21
		Paper stacker (not included)	21
		Recording paper	22
		Connections	24
Date and time, your logo and facsimile telephone number		25	
Setup (Handset)	Location	29	
	Battery charge	30	
	Belt clip	31	
	Headset (not included)	31	
Volumes	Adjusting volumes	32	
Telephone	Making and Answering Calls	Making a voice call with the handset	33
		Making a voice call with the main unit	34
		Answering a voice call	35
		Paging the handset from the main unit (handset locator)	35
		Remote monitor	36
		TONE, FLASH and PAUSE buttons	37
		Dialing mode (touch tone or pulse)	38
	Automatic Dialing (Handset)	Storing telephone numbers in the handset	39
		Making a voice call with the handset using stored numbers	39
		Storing a telephone number in the DIRECT button	40
		Dialing a stored number in the DIRECT button	40
	One-Touch Dial	Storing names and telephone numbers in the One-Touch Dial	41
		Making a voice call using the One-Touch Dial	42
	JOG DIAL	Storing names and telephone numbers in the JOG DIAL directory	43
		Making a voice call using the JOG DIAL directory	45
	Caller ID	Caller ID service from your phone company	46
		Viewing the Caller ID list on the display	47
		Calling back from the Caller ID list	48
		Storing telephone numbers in the One-Touch Dial and JOG DIAL directory from the Caller ID list	49
		Erasing all callers' information	50
Storing your area code		50	
Automatic Caller ID list		51	
Voice Contact	Talking to the caller after fax transmission or reception	52	

Fax/Copy

Sending Faxes	Sending a fax manually	53
	Sending a fax using the One-Touch Dial	54
	Sending a fax using the JOG DIAL directory	55
	IQ-FAX	56
	Documents you can send	59
	Sending report for confirmation	60
	Automatic journal report	61
	Delayed transmission (sending a fax at a specified time)	62
	From memory	63
	Multiple stations	64
	Overseas mode	67
	Connecting tone	67

Receiving Faxes	Setting the unit to receive calls	68
	TEL mode (answering all calls manually)	70
	FAX ONLY mode (all calls are received as faxes)	71
	Using the unit with an answering machine	73
	Distinctive Ring service (ring pattern detection feature)	76
	TEL/FAX mode (receiving voice calls with rings and fax calls without rings when you are near the unit)	78
	Extension telephone	82
	Fax activation code	82
	Other size documents	83
	Silent detection (receiving faxes from older model fax machines)	84
	Memory reception alert	84
	Friendly reception	85
	Auto disconnection	85
	Pager call - when your unit receives a fax	86
	Film detection	87

Copying	Making a copy	88
----------------	-------------------------	----

Help

Error Messages	Reports	90
	Display	91

Operations	When a function does not work, check here before requesting help	93
	If a power failure occurs	98

Jams	Recording paper jams	99
	Sending document jams	101
	Sending document does not feed, or multi-feeds	102

Battery	Replacing the handset battery	103
----------------	---	-----

Ink Film	How much film you have left	104
	Replacing the film cartridge	104

Cleaning	Document feeder	106
	Thermal head and black bar	107
	Charge contacts	108

Initial Preparation

Telephone

Fax/Copy

Help

General Information





Comienzo rápido en español

General Information	Print Reports	Printing the feature settings, telephone numbers, journal, printer test list, broadcast list and Caller ID list	109
	Display Contrast	Changing the display contrast	110
	Reset	Resetting the advanced features	110
	FCC Information	List of FCC requirements and information	111
	Limited Warranty	Limited Warranty	112
		Servicenter Directory	113
		Notes for product service and shipping the product	114
	Energy Star	Energy Star	114
Specifications	Technical data about this product	115	

Comienzo rápido en español	Comienzo rápido en español	116
-----------------------------------	---	-----

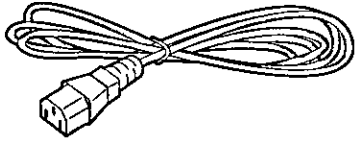
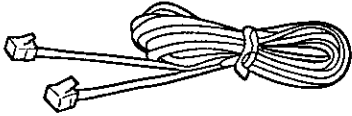
Index	124	
Features Summary	Summary of user programmable features	126

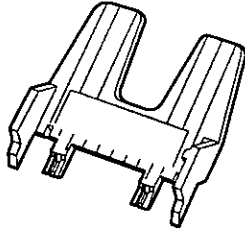
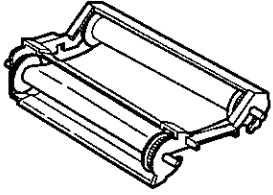
Included accessories

<p>Power cord 1</p>  <p>Part No. PFJA1030Z</p>	<p>Telephone line cord 1</p>  <p>Part No. PQJA10075Z</p>	<p>Cordless handset 1</p>  <p>— The rechargeable battery is pre-installed.</p>
<p>Paper tray 1</p>  <p>Part No. PFZX2FPC141M</p>	<p>Film cartridge 1 (with free starter film)</p>  <p>— The film cartridge is pre-installed.</p>	<p>Belt clip 1</p>  <p>Part No. PQKE10079Z1</p>

- If any items are missing or damaged, check with the place of purchase.
- The part numbers listed above are subject to change without notice.
- Save the original carton and packing materials for future shipping and transportation of the unit.

Accessories

Accessory order information

The free starter film cartridge is only 20 meters (65') long. We recommend that you buy regular film cartridge [100 m (328')] for continuous use of your unit.

For best results, use genuine Panasonic film cartridge Model No. KX-FA65.

To order, call toll-free 1-800-332-5368 or see the fax order instructions below.

Fax order: Please send a fax to 1-800-237-9080. Include: your name, shipping address, telephone number, credit card type, number, expiry date and your signature, order part number and quantity, and delivery method – overnight, 2nd day, or ground.

Model No.	Description	Specifications
KX-FA65	Film cartridge	216 mm x 100 m (8½" x 328') roll
PFZXFPC141M	Paper stacker	For stacking printed paper
KX-A36	Rechargeable battery	Ni-Cd battery
KX-TCA90	Headset	For a hands-free telephone conversation

Note:

- The film cartridge is not reusable. Do not rewind and use the film again.

Help function

You can print a quick reference for assistance as follows.

1 Press **HELP**.

Display: **PRESS [▼▲] & [SET]**

2 Press **▼** or **▲** until the desired item is displayed. The following items are available.

1. How to program your unit

1. HOW TO SET UP

2. How to store names in the JOG DIAL directory and how to dial them

2. JOG/AUTO DIAL

3. Help with problems sending faxes

3. FAX SENDING

4. Help with problems receiving faxes

4. FAX RECEIVING

5. How to use the copier function

5. COPIER

6. Frequently asked questions and answers

6. Q and A

7. Explanation of error messages shown on the display

7. ERRORS

8. List of available reports

8. REPORTS

9. How to use the Caller ID service

9. CALLER ID

3 Press **START/SET/COPY**.

PRINTING

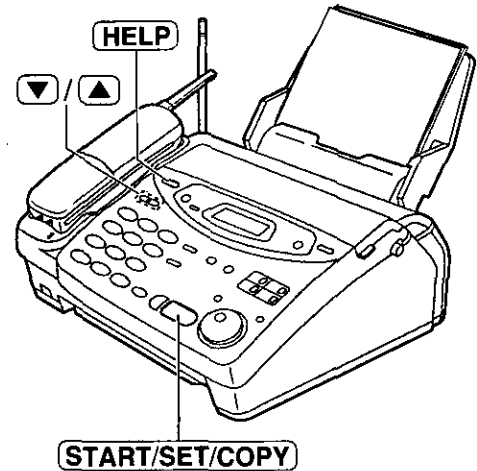

Finding the Controls (Main Unit)

Location

- To adjust volumes (p. 32).
- To select feature settings during programming.
- To select a resolution (p. 53).

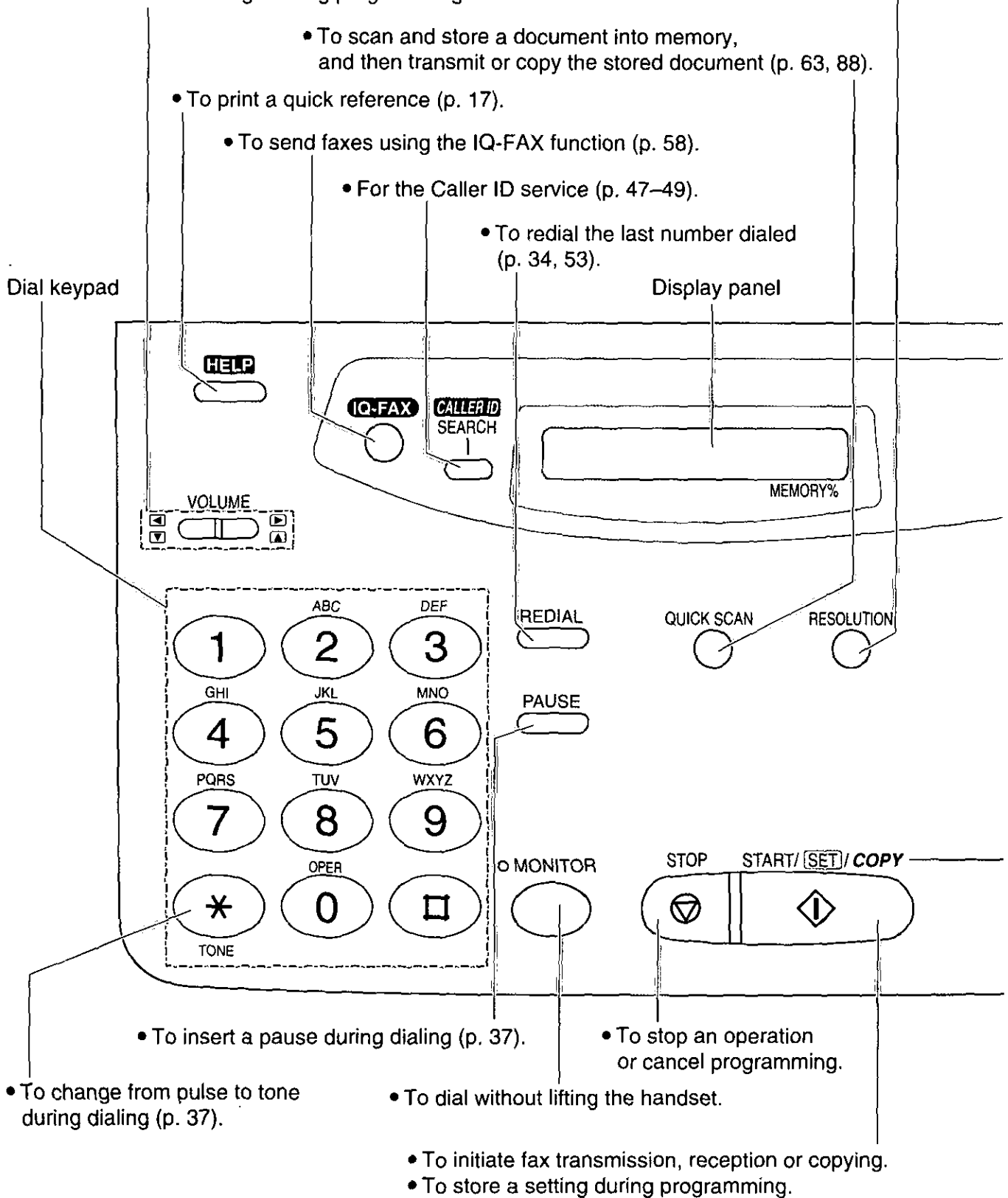

Finding the Controls (Main Unit)

- To page or locate the handset (p. 35).

- For transmission to multiple stations (p. 64–66).
- For the One-Touch Dial (p. 41, 42, 54).

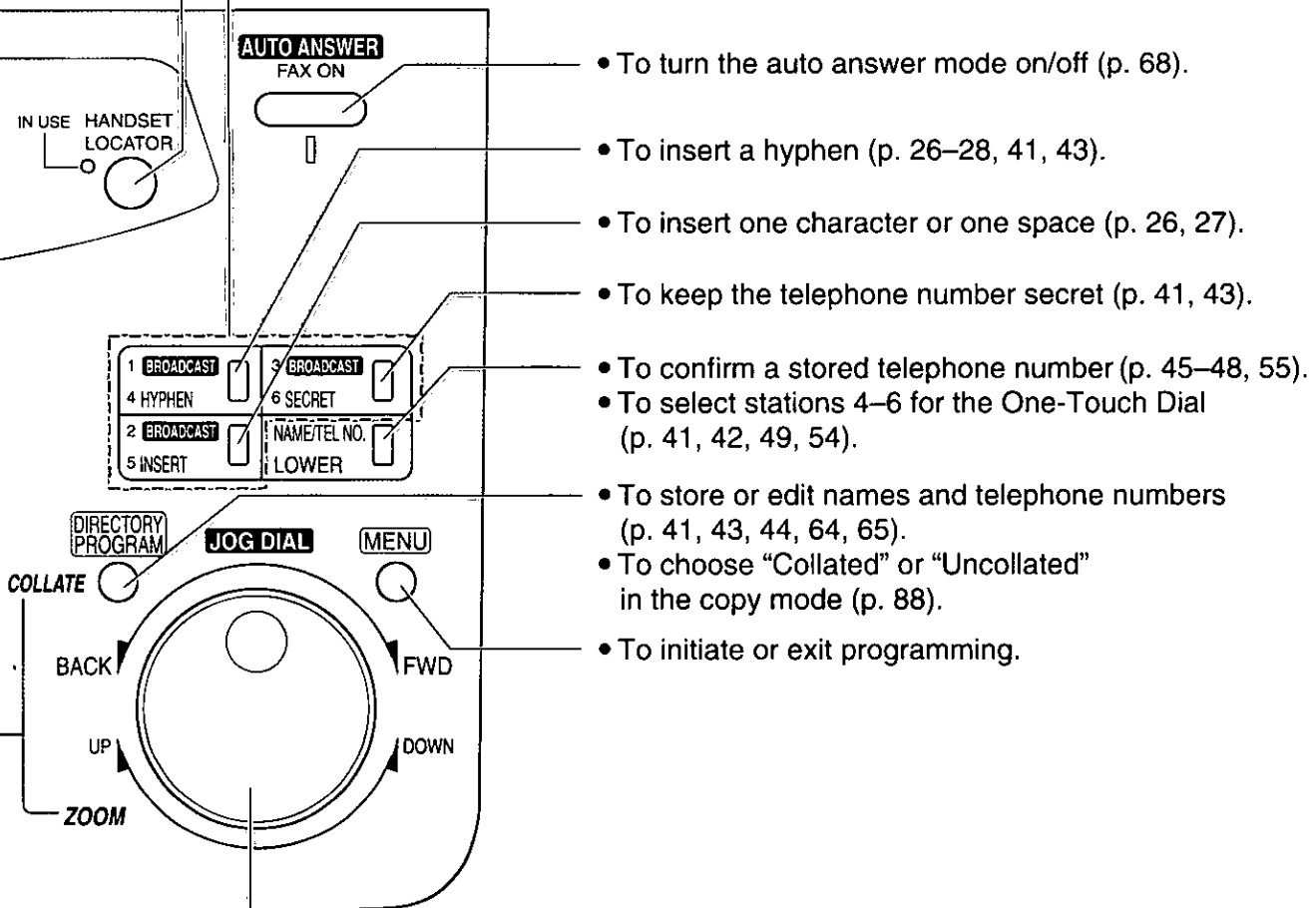

- To turn the auto answer mode on/off (p. 68).

- To insert a hyphen (p. 26–28, 41, 43).

- To insert one character or one space (p. 26, 27).

- To keep the telephone number secret (p. 41, 43).

- To confirm a stored telephone number (p. 45–48, 55).
- To select stations 4–6 for the One-Touch Dial (p. 41, 42, 49, 54).

- To store or edit names and telephone numbers (p. 41, 43, 44, 64, 65).
- To choose “Collated” or “Uncollated” in the copy mode (p. 88).

- To initiate or exit programming.

- To search for a stored name (p. 45, 55).
- To select characters during programming (p. 27).
- To select the basic features during programming (p. 126).
- To select an enlargement/reduction rate in the copy mode (p. 88, 89).

Finding the Controls / Setup (Main Unit)

Overview

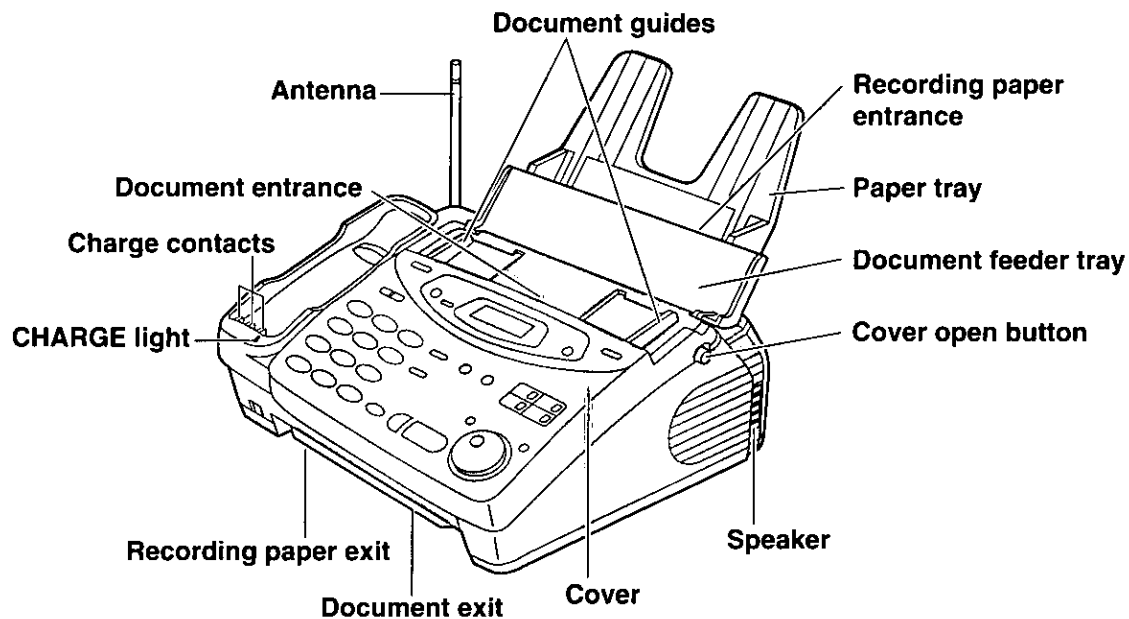

Note:

- The document and recording paper will be ejected from the front of the unit. Install the unit on a desk or floor with a smooth surface and do not place anything in front of the unit.

Before installation

- 1 Remove the shipping tape.

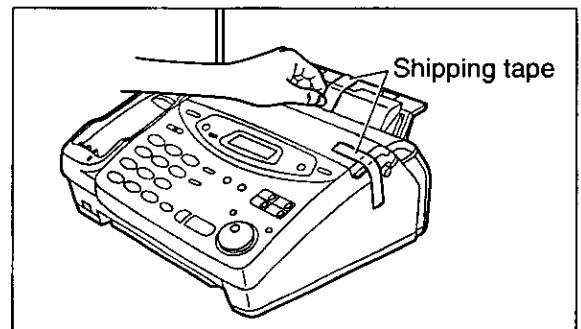

- 2 Open the cover by pressing the cover open button.

- 3 Lift the film cartridge, remove the leaflet and replace the film cartridge.

- 4 Close the cover securely by pushing down on the dotted area at both ends.

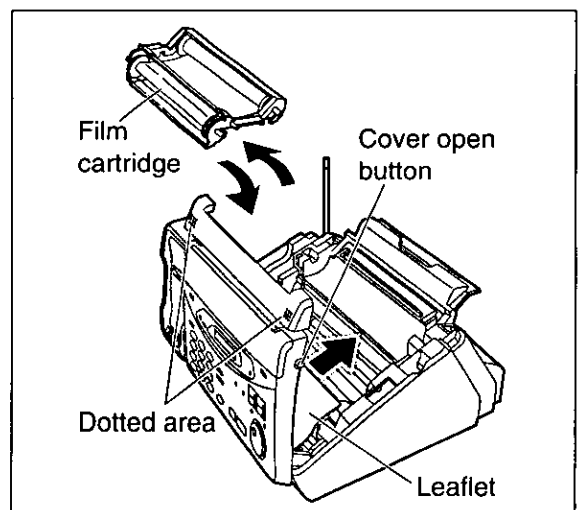

Paper tray

Insert the two tabs on the paper tray into the slots on the back of the unit.

- Do not place the unit in areas where the paper tray may be obstructed by a wall etc.

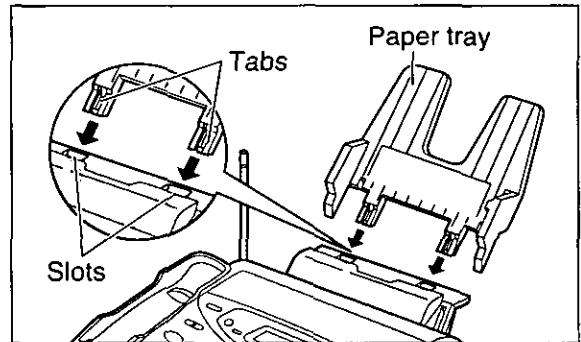

Paper stacker (not included)

To stack printed paper, a paper stacker is available as an accessory. To order, see page 16.

- 1 Remove the shipping tape from the paper stacker.
- 2 Lift the front of the unit and hold the aluminum sheet up to prevent it being bent by the paper stacker while inserting the paper stacker into the side slots.

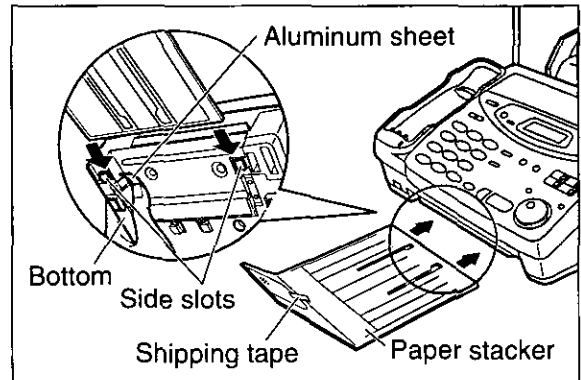

- 3 Confirm that the paper stacker is locked into the center slots and slide back.

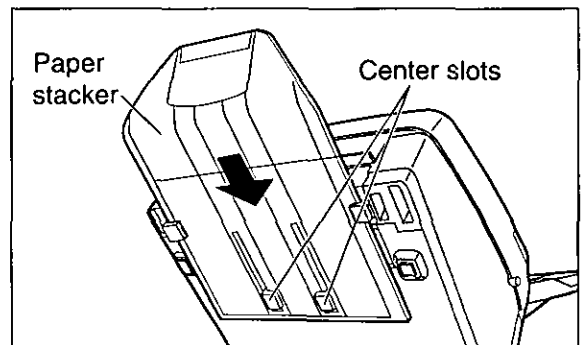

- 4 Slide the paper stacker forward until it stops.

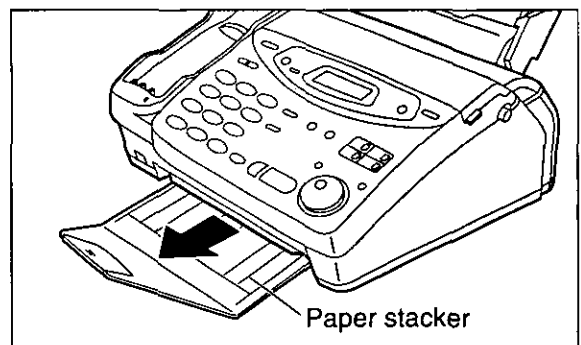

Setup (Main Unit)

Using legal size paper

- 1 Press the dotted area on the paper stacker extender.

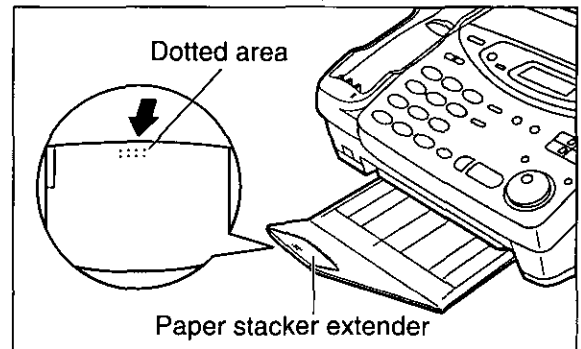

- 2 Open the paper stacker extender.

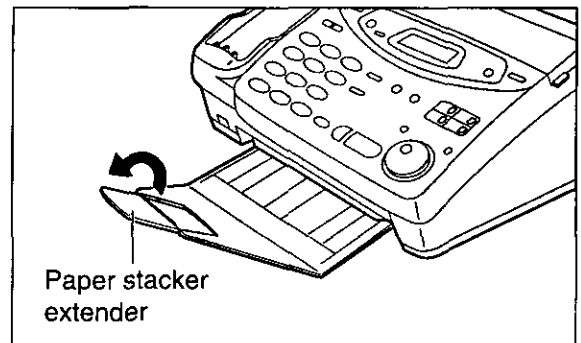

Recording paper

Letter or legal size recording paper can be loaded. The paper tray can hold up to 150 sheets of 75 g/m² (20 lb.) paper. You may use 60 g/m² to 90 g/m² (16 lb. to 24 lb.) paper.

For best results, only use inkjet paper such as Hammermill® Jet Print. If you use other types of paper, the print quality may be affected.

- 1 Fan the stack of paper to prevent a paper jam.

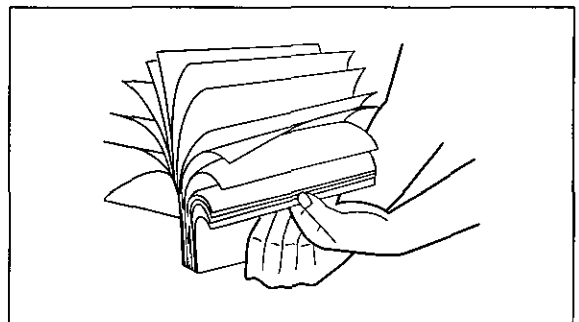

Setup (Main Unit)

- 2** Pull the tension bar forward and hold open while inserting the paper.
- The height of the stack of the paper should not exceed the upper limit on the paper tray, otherwise the paper may jam or multi-feed.
 - The paper should not be over the tab.
 - If the paper is not inserted correctly, readjust the paper or the paper may jam.

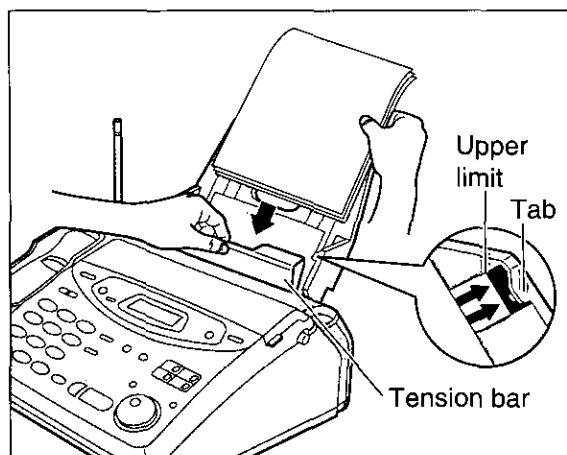
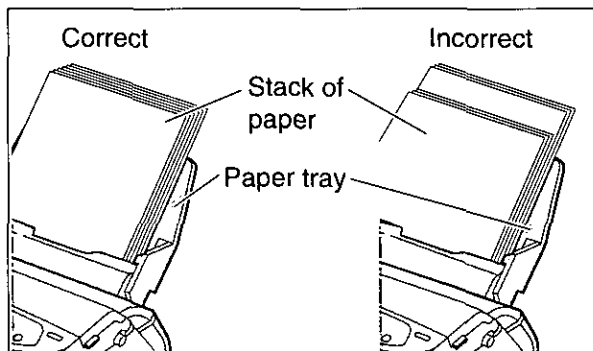

Note:

- Avoid paper with a cotton and/or fiber content that is over 20%, such as letterhead paper or paper used for resumes.
- Do not use different types or thicknesses of paper in the paper tray at the same time. This may cause a paper jam.
- Avoid extremely smooth or shiny paper that is highly textured. Also avoid paper that is coated, damaged or wrinkled.
- Avoid double-sided printing.
- Do not use paper printed from this unit for double-sided printing with other copiers or printers, or the paper may jam.
- Do not reinsert the ejected paper into the recording paper exit.
- Some paper only accepts print on one side. Try using the other side of paper when you are not happy with the print quality.

Adding paper to the paper tray

1. Pull the tension bar forward and hold open while removing all of the installed paper.
2. Add paper to the removed paper and straighten.
3. Fan the stack of paper.
4. Pull the tension bar forward and hold open while inserting the paper.

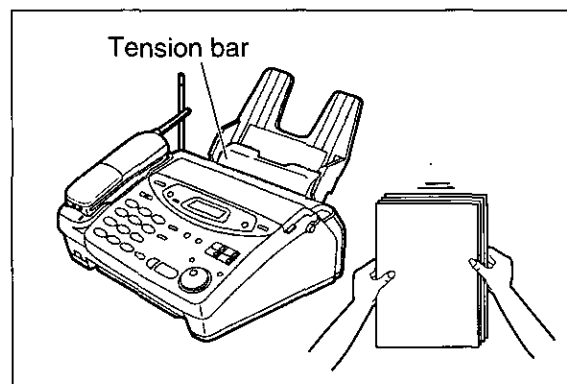

Setup (Main Unit)

Connections

- 1 Connect the telephone line cord.
- 2 Connect the power cord.
 - The unit will automatically start to detect the dialing mode of your telephone line (see below).
 - When the power is turned on for the first time, the unit will print some basic information.

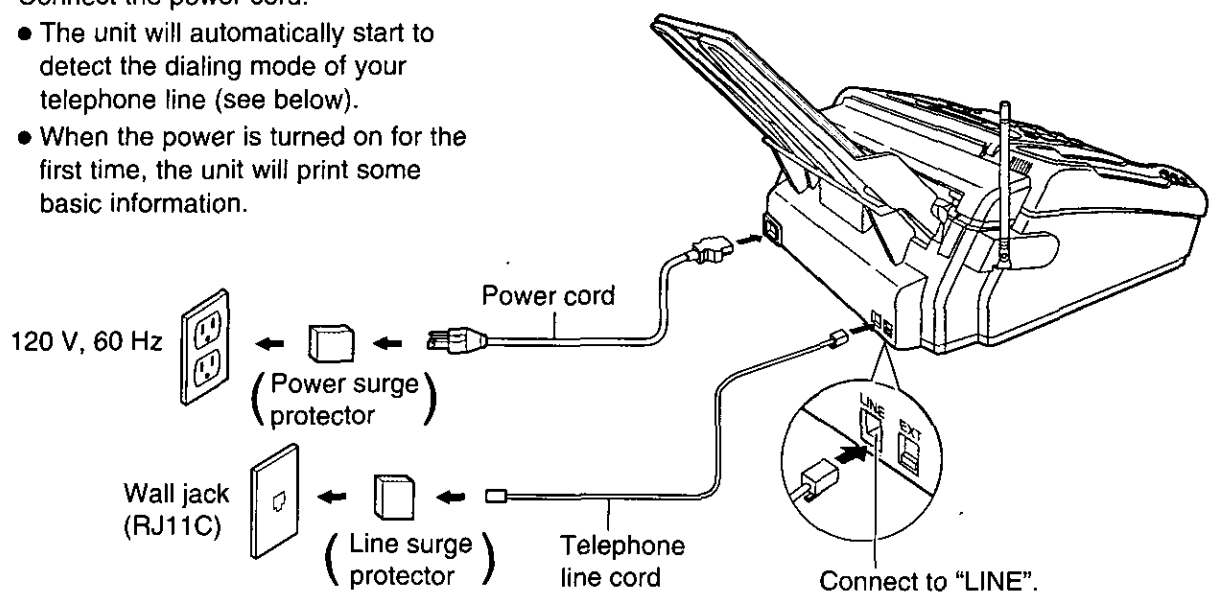

Note:

- For additional equipment protection, we recommend the use of a surge protector. The following types are available; TELESPIKE BLOK MODEL TSB (TRIPPE MFG. CO.), SPIKE BLOK MODEL SK6-0 (TRIPPE MFG. CO.), SUPER MAX (PANAMAX) or MP1 (ITW LINX).
The warranty does not cover damage due to power line surges or lightning.
- When you operate this product, the power outlet should be near the product and easily accessible.
- If you want to connect an answering machine to the unit, see page 73.

Automatic dialing mode setting

- When the telephone line cord and the power cord are connected, the unit will automatically start to detect the dialing mode of your telephone line.

Display: CHECKING LINE

Wait until one of the following messages is displayed.

LINE IS TONE Your line has touch tone service.

LINE IS PULSE Your line has rotary pulse dial service.

- If the power cord is disconnected or a power failure occurs, the unit will detect the dialing mode again when power is restored.
- If you connect the power cord before connecting the telephone line cord, the following messages will be shown alternately.

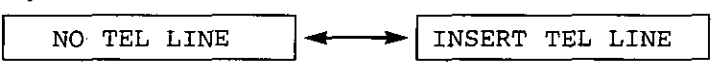

Connect the telephone line cord.

Date and time, your logo and facsimile telephone number

You should program the date and time, your logo and facsimile telephone number. This information will be printed on each page transmitted from your unit, fulfilling the requirements of the Telephone Protection Act of 1991.

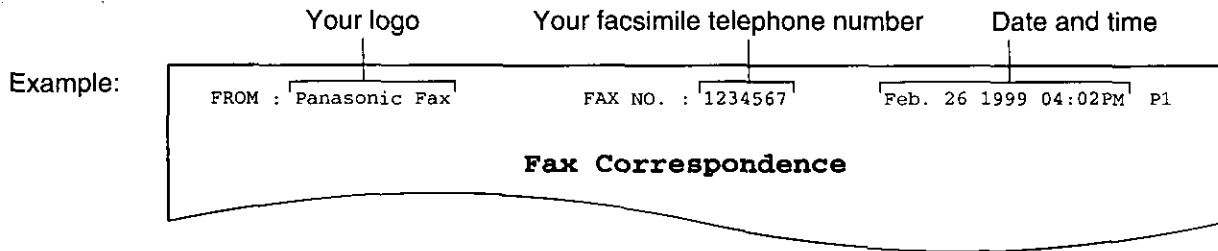

Setting the date and time

1 Press **MENU**.
Display: 1.SYSTEM SET UP

2 Press **⏏**, then **0 1**.
SET DATE & TIME

3 Press **START/SET/COPY**.
M:01/D:01/Y:99
Cursor

4 Enter the correct month/day/year by selecting 2 digits for each using the dial keypad.
Example: Aug. 10, 1999
Press **0 8 1 0 9 9**.
M:08/D:10/Y:99

5 Press **START/SET/COPY**.
TIME: 12:00AM

6 Enter the correct hour/minute by selecting 2 digits for each using the dial keypad.
Press ***** to select "AM" or "PM".
Example: 3:15PM
1. Press **0 3 1 5**.
TIME: 03:15AM

2. Press ***** until "PM" is displayed.
TIME: 03:15PM

7 Press **START/SET/COPY**.
SETUP ITEM []

8 Press **MENU**.

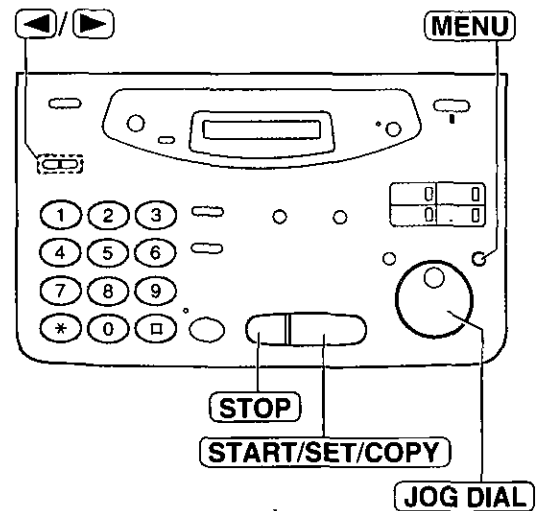

Note:

- You can enter the number by rotating **JOG DIAL** in steps 4 and 6. In this case, press **▶** to move the cursor.
- The accuracy of the clock is approximately ±60 seconds a month.

To correct a mistake

- Press **◀** or **▶** to move the cursor to the incorrect number, and make the correction.
- If you press **STOP** while programming, the display will return to the previous one.

Setup (Main Unit)

Setting your logo

The logo can be your company, division or name.

1 Press **MENU**.
Display: 1.SYSTEM SET UP

2 Press **□**, then **0 2**.
YOUR LOGO

3 Press **START/SET/COPY**.
LOGO=

4 Enter your logo, up to 30 characters, by using the dial keypad. See next page for details.

Example: Bill

1. Press **2** twice.
LOGO=B
Cursor

2. Press **4** six times.
LOGO=Bi

3. Press **5** six times.
LOGO=Bi

4. Press **▶** to move the cursor to the next space and press **5** six times.

LOGO=Bill

5 Press **START/SET/COPY**.
SETUP ITEM []

6 Press **MENU**.

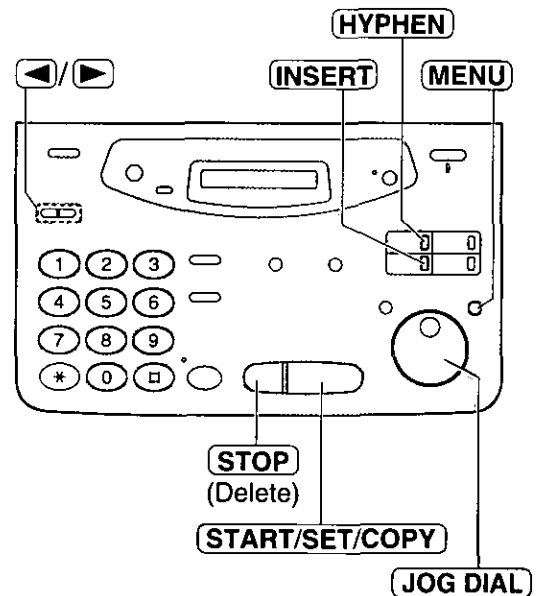

Note:

- You can enter your logo by rotating **JOG DIAL** (see next page).

To correct a mistake

- Press **◀** or **▶** to move the cursor to the incorrect character, and make the correction.

To delete a character





- Move the cursor to the character you want to delete and press **STOP**.

To insert a character

1. Press **◀** or **▶** to move the cursor to the position to the right of where you want to insert the character.
2. Press **INSERT** (One-Touch Dial key 2) to insert a space and enter the character.

To select characters with the dial keypad

Pressing the dial keys will select a character as shown below.

Keys	Characters
①	1 [] { } + - / = , . _ ` : ; ?
②	A B C a b c 2
③	D E F d e f 3
④	G H I g h i 4
⑤	J K L j k l 5
⑥	M N O m n o 6
⑦	P Q R S p q r s 7
⑧	T U V t u v 8
⑨	W X Y Z w x y z 9
⑩	0 () < > ! " # \$ % & ¥ * @ ^ ' →
	HYPHEN key (To insert a hyphen.)
	INSERT key (To insert one character or one space.)
STOP	Delete key (To delete a character.)
	◀ key (To move the cursor to the left.)
	▶ key (To move the cursor to the right.) To enter another character using the same number key, move the cursor to the next space.

To select characters using the JOG DIAL

Instead of pressing the dial keys, you can select characters using the JOG DIAL.

1. Rotate **JOG DIAL** until the desired character is displayed.
2. Press  to move the cursor to the next space.
 - The character displayed in step 1 is inserted.
3. Return to step 1 to enter the next character.

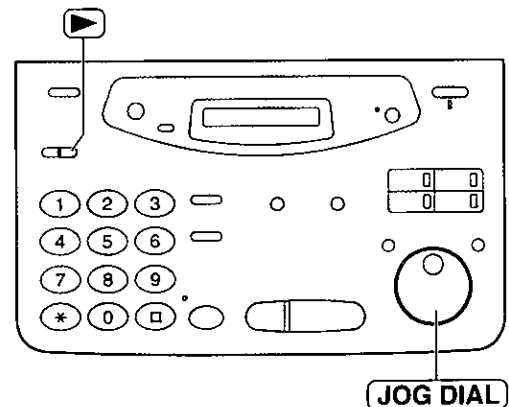

Display order of characters

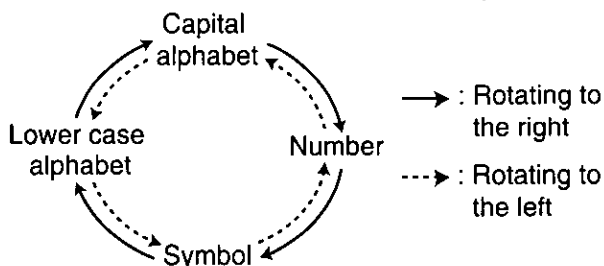

Setup (Main Unit)

Setting your facsimile telephone number

- 1 Press **MENU**.
Display: 1.SYSTEM SET UP
- 2 Press **□**, then **0 3**.
YOUR FAX NO.
- 3 Press **START/SET/COPY**.
NO. =
- 4 Enter your facsimile telephone number up to 20 digits using the dial keypad.
Example: NO. =1234567
- 5 Press **START/SET/COPY**.
SETUP ITEM []
- 6 Press **MENU**.

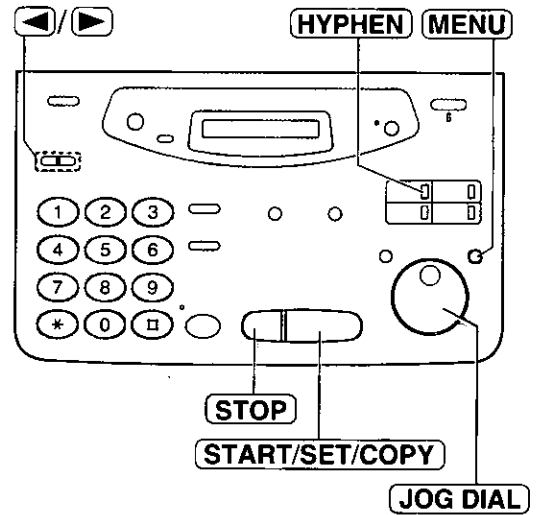

Note:

- You can enter your facsimile telephone number by rotating **JOG DIAL**. If using **JOG DIAL**, press **▶** to move the cursor.
- The ***** button replaces the digit with a "+" and the **□** button replaces it with a space.
Example (using the dial keypad): +234 5678
Press ***234□5678**.
- To enter a hyphen in a telephone number, press **HYPHEN** (One-Touch Dial key 1).

To correct a mistake

- Press **◀** or **▶** to move the cursor to the incorrect number, and make the correction.

To delete a number

- Move the cursor to the number you want to delete and press **STOP**.

Location

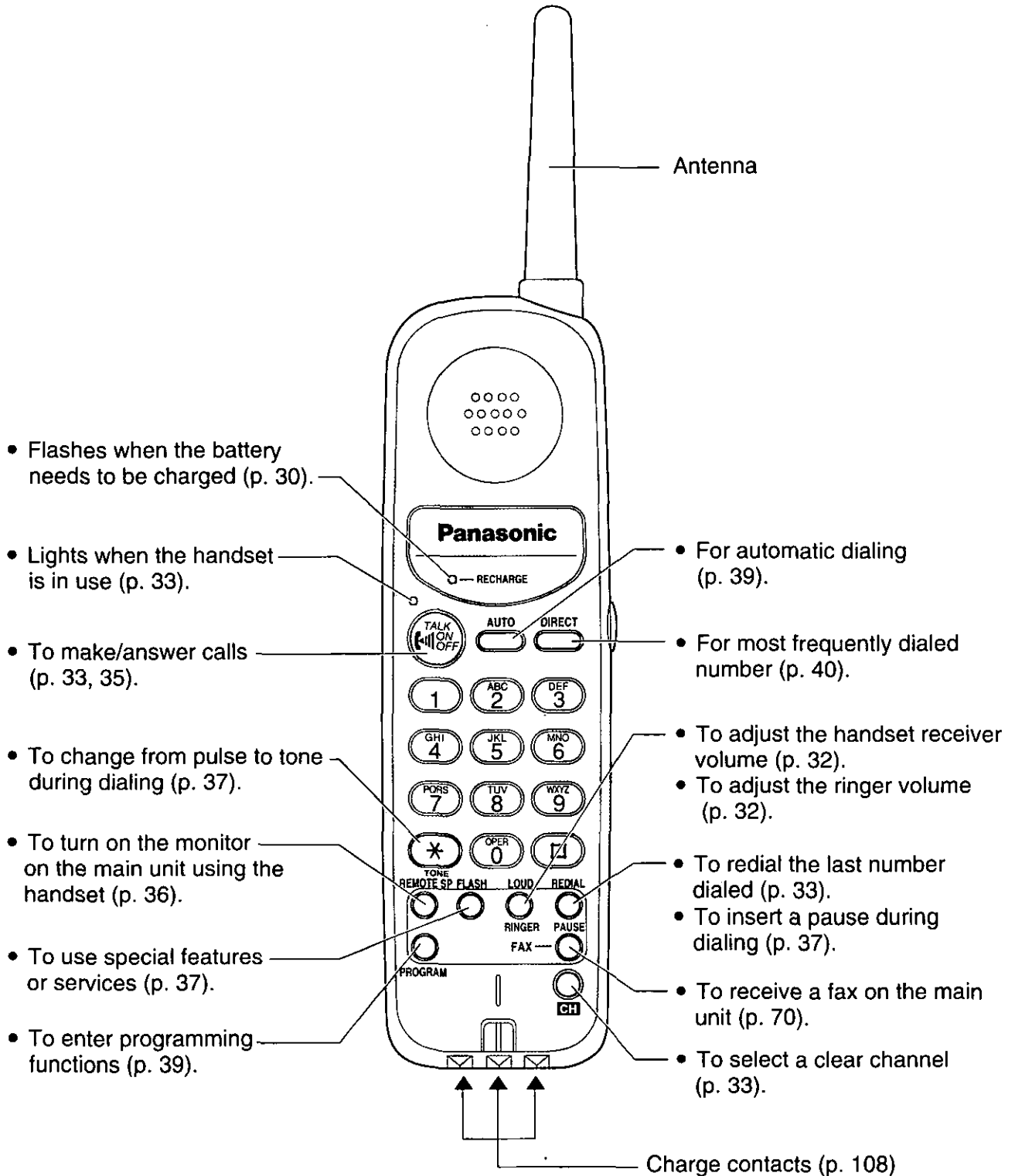

Setup (Handset)

Battery charge

Place the handset on the cradle of the main unit for about **4 hours**.

- The CHARGE light will turn on.

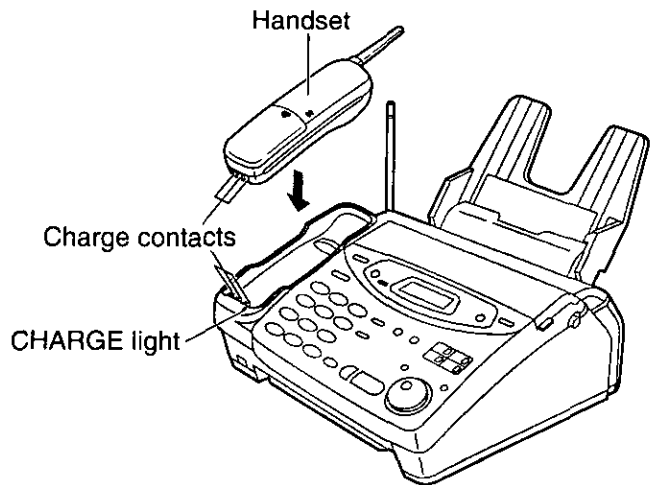

Note:

- Clean the handset and the main unit charge contacts with a dry cloth once a month, or the battery may not charge properly (p. 108).
- The battery cannot be overcharged.

Automatic security code setting

Whenever you place the handset on the main unit, the unit will automatically select one of a million security codes. These codes help to avoid unauthorized use of your telephone line by another cordless telephone.

Battery life

If your Panasonic battery is fully charged, the battery life will last as follows.

While in use (on conversation)	Up to about 8 hours
While not in use (stand-by/off the main unit)	Up to about 21 days

Note:

- Battery life may vary depending on usage conditions and ambient temperature.

Recharge

When the RECHARGE indicator flashes or the handset beeps intermittently, place the handset on the cradle to recharge the battery.

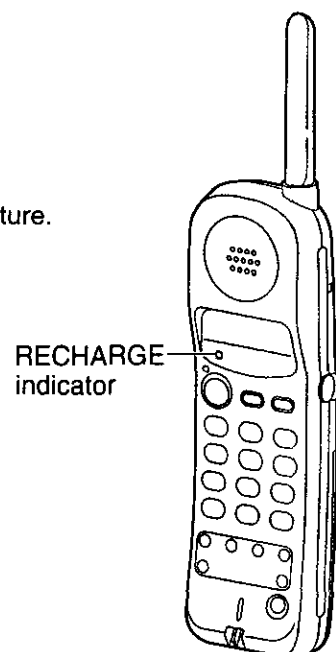

Belt clip

■ To install the belt clip

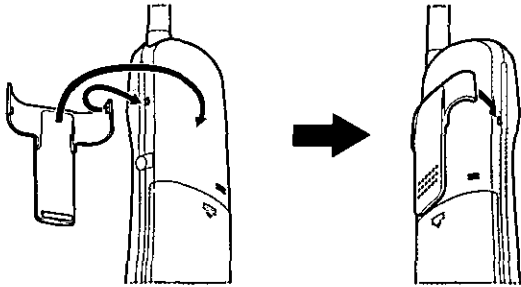

■ To remove the belt clip

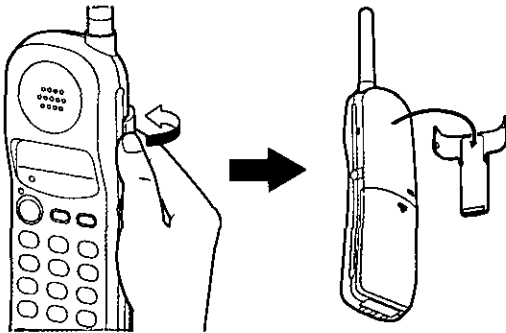

Wearing the belt clip

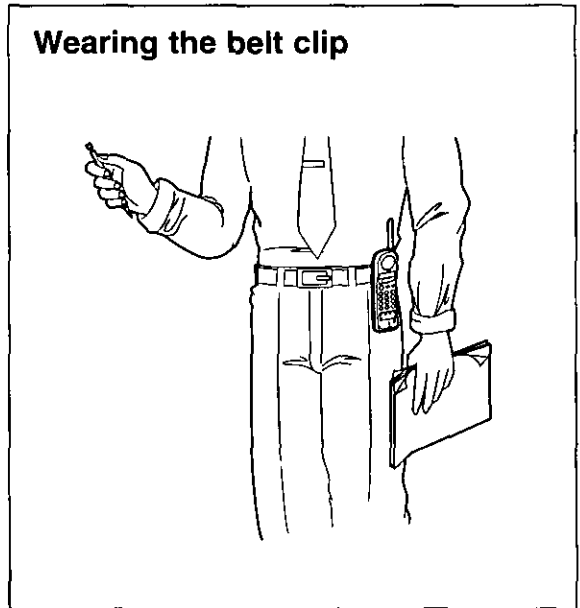

Headset (not included)

Plugging the headset into the handset allows a hands-free telephone conversation. For best result, use a Panasonic headset Model No. KX-TCA90. To order, see page 16.

■ To connect the headset

Open the headset jack cover, and connect the headset to the headset jack as shown below.

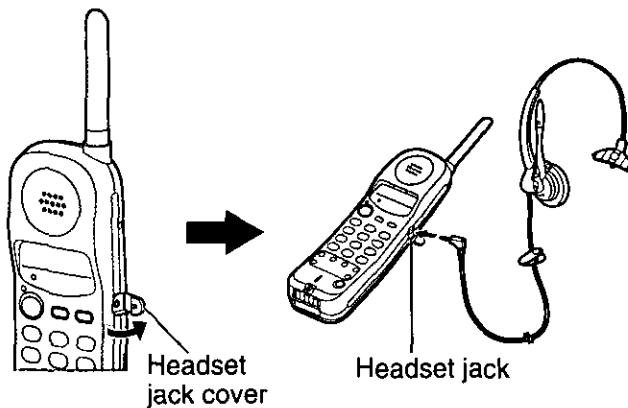

Wearing the headset

1. Place the headset on your head and attach the clothing clip to the desired position.

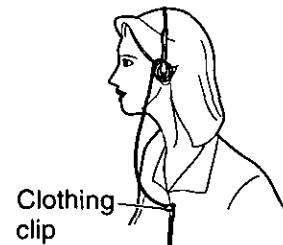

2. Adjust the microphone near your mouth.



Volumes

Adjusting volumes

Handset

Ringer volume

3 levels (high/low/off) are available.

Make sure the TALK indicator is off.

1. Press **LOUD/RINGER**.
 - The current ringer will sound.
 2. To change the volume, press **LOUD/RINGER** again within 5 seconds.
 - The new ringer will sound.
 - If you do not press **LOUD/RINGER** within 5 seconds, the volume will not change.
- **To turn the ringer off:**
Press and hold **LOUD/RINGER** until 2 beeps sound.
 - To turn the ringer back on, press **LOUD/RINGER**. It will sound at a high level.

■ **While the ringer volume is set to off:**

When receiving a call, the handset will not ring, and the TALK indicator will flash.

Handset volume

3 levels (high/middle/low) are available.

While talking, press **LOUD/RINGER**.



Main unit

Ringer volume

4 levels (high/middle/low/off) are available.

While the unit is idle, press **▼** or **▲**.

■ **To turn the ringer off:**

1. Press **▼** repeatedly until the following message is displayed.

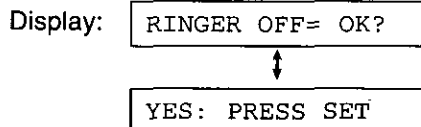

2. Press **START/SET/COPY**.

- To turn the ringer back on, press **▲**.

■ **While the ringer volume is set to off:**

The display will show the following message.

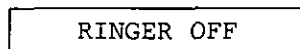

When a call is received, the unit will not ring and will display the following.

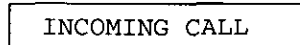

Monitor volume

8 levels (high to low) are available.

While using the monitor, press **▼** or **▲**.

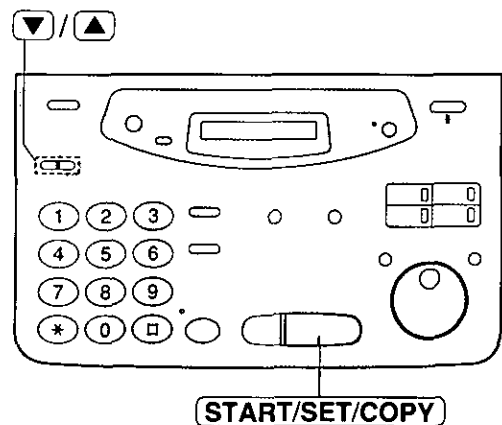

Making a voice call with the handset

- 1** ■ **Handset is off the main unit:**
Press **TALK**.
 - The TALK indicator will light.■ **Handset is on the main unit:**
Lift the handset and press **TALK**.
 - The TALK indicator will light.
- 2** Dial the telephone number.
 - If you misdial, press **TALK** and start again from step 1.
- 3** When finished talking, press **TALK** or place the handset on the main unit.
 - The TALK indicator will turn off.

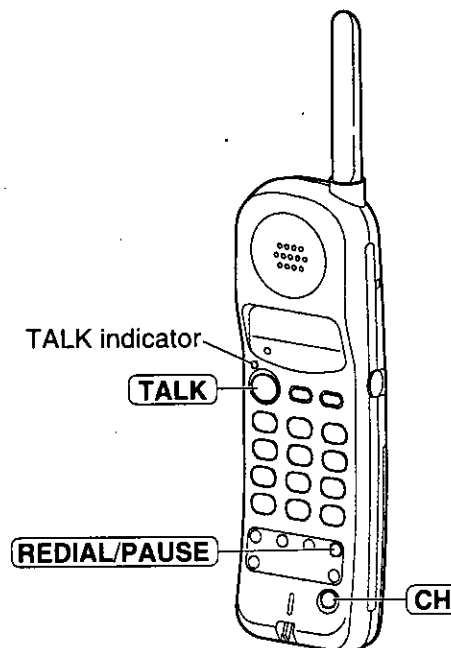

Telephone

Note:

- If an alarm tone sounds when you press **TALK**:
 - move towards the main unit, or
 - place the handset on the main unit.Then try again.
- If the TALK button on the handset is pressed while using the main unit, the call is switched to the handset and the main unit is disconnected.

To redial the last number

Regardless of whether the main unit or the handset was used, the last number dialed will be redialed.

1. Press **TALK**.
2. Press **REDIAL/PAUSE**.

If noise interferes with the conversation

Press **CH** to select a clear channel or move closer to the main unit.

While the handset is in use

On the main unit, the IN USE indicator lights and following will be displayed.

Display: **CORDLESS IN USE**

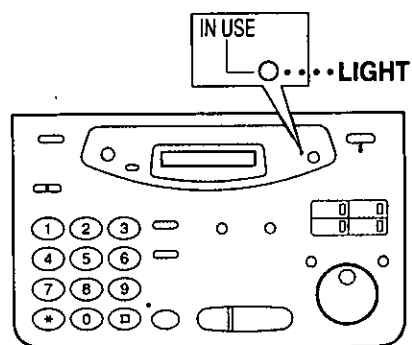

Making and Answering Calls

Making a voice call with the main unit

1 Press **MONITOR**.

Display: TEL=

2 Dial the telephone number.

Example: TEL=2345678

- If you misdial, hang up and dial again.

3 When the other party answers, speak with the handset.

4 When finished talking, replace the handset.

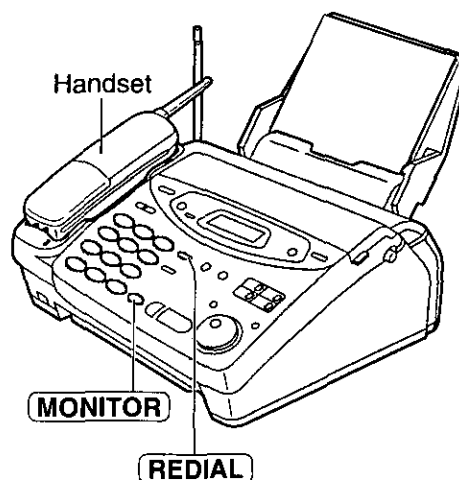

Note:

- If the TALK button on the handset is pressed while using the main unit, the call is switched to the handset and the main unit is disconnected.

To redial the last number

Regardless of whether the main unit or the handset was used, the last number dialed will be redialed.

1. Press **MONITOR**.

2. Press **REDIAL**.

3. When the other party answers, speak with the handset.

- If the line is busy when using the **MONITOR** button, the unit will automatically redial the number up to 14 times.
- During redial, the following will be displayed.

Display: WAITING REDIAL

Answering a voice call

- 1 ■ Handset is off the main unit:**
Press **TALK** when the handset rings.
 - You can also answer a call by pressing any dial key 0 to 9, *, or #.
(Any key talk feature)
- Handset is on the main unit:**
Lift the handset when the main unit rings.

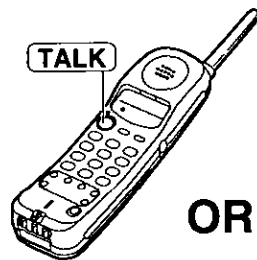

OR

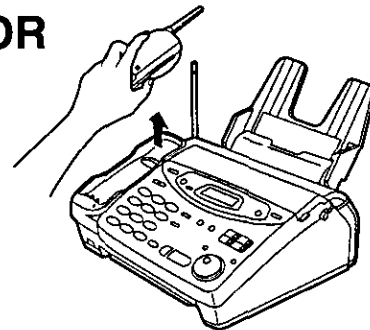

Telephone

- 2** When finished talking, press **TALK** or place the handset on the main unit.

Paging the handset from the main unit (handset locator)

Using this feature, you can locate the handset if misplaced.

- 1 Main unit:**
Press **HANDSET LOCATOR**.
 - The IN USE indicator will flash and start paging the handset for 1 minute.
 - To stop paging, press **HANDSET LOCATOR** again.
- 2 Handset:**
Press **TALK** twice to stop paging.

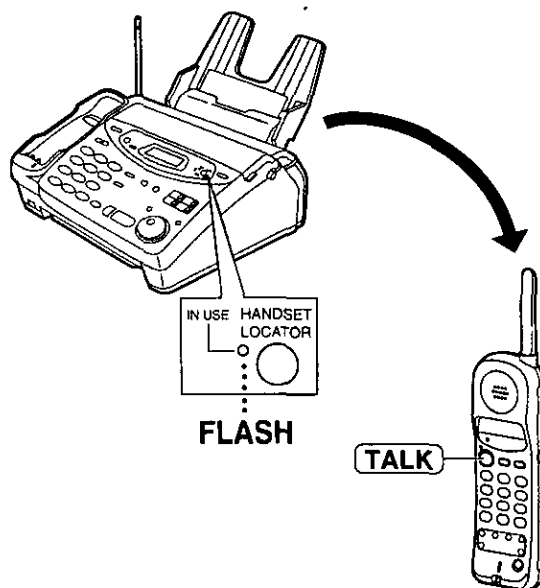

Making and Answering Calls

Remote monitor

Switching a call with the handset to the MONITOR

- 1 Press **REMOTE SP** during a call with the handset.
 - The TALK indicator flashes.
 - The call is switched to the main unit.
 - On the main unit, the MONITOR indicator lights.
- 2 When you hear the other party, press **TALK** on the handset to begin the conversation.
 - To hang up, press **TALK**.



Making a call using the handset as a remote control

- 1 Press **REMOTE SP**.
Display:
- 2 Dial the telephone number.
 - You can also dial with the main unit keypad.Example:
- 3 When you hear the other party answers, press **TALK** on the handset to begin the conversation.
- 4 To hang up, press **TALK**.

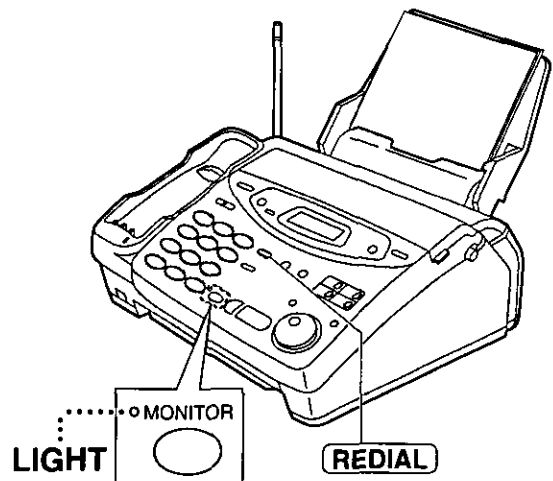

To redial the last number

Regardless of whether the main unit or the handset was used, the last number dialed will be redialed.

1. Press **REMOTE SP**.
2. Press **REDIAL**/**REDIAL/PAUSE**.

TONE, FLASH and PAUSE buttons

TONE button

The **TONE** (*) button is used for rotary pulse dial services and allows you to temporarily change from pulse to tone mode during a dialing operation. When you hang up, the unit will automatically return to pulse mode.

FLASH button (handset only)

The **FLASH** button allows you to use special features of a host exchange (if connected) or local telephone company services such as call waiting. For feature details, contact your host exchange supplier or local telephone company.

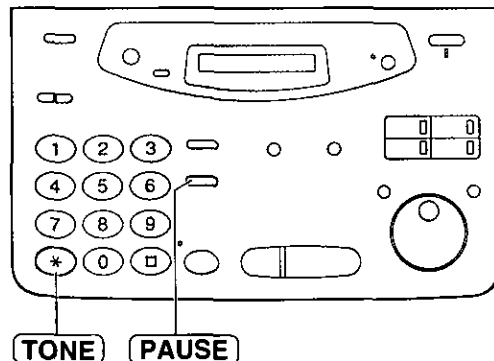

Telephone

Entering pauses

When the **PAUSE**/**REDIAL/PAUSE** button is pressed during dialing, a pause will be inserted. Pressing **PAUSE**/**REDIAL/PAUSE** once creates a 5 second pause.

Example 1:

If your unit is connected to a host exchange, insert a pause to get an outside line.

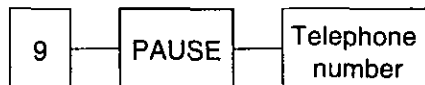

Line access code

Example 2:

If a transmission error occurs during an overseas transmission, add two pauses at the end of the telephone number.

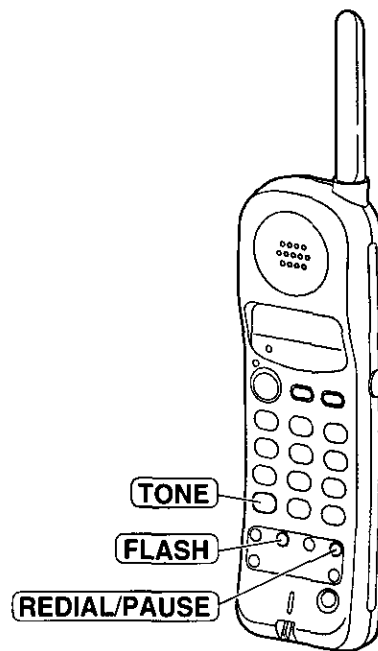
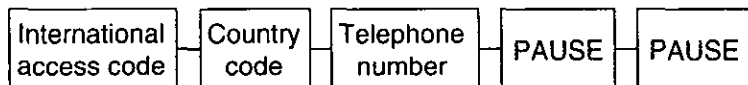

Note:

- TONE and PAUSE can be stored into a telephone number in the One-Touch Dial and the JOG DIAL directory.

Storing telephone numbers in the handset =====

You can store up to 10 telephone numbers in the handset. The dial keys (0 to 9) function as memory stations. Make sure the TALK indicator is off.

- 1** Press **PROGRAM**.
 - The TALK indicator will flash.
- 2** Enter the telephone number up to 22 digits.
 - If you misdial, press **PROGRAM** to end storing, and start again from step 1.
- 3** Press **AUTO**.
- 4** Press a memory station number (0 to 9).
 - A one beep confirmation tone will sound.
 - The TALK indicator will turn off.
 - To store other numbers, repeat steps 1 to 4.

Note:

- Numbers stored in the handset cannot be accessed by the main unit.
- A pause entered in a telephone number counts as one digit.

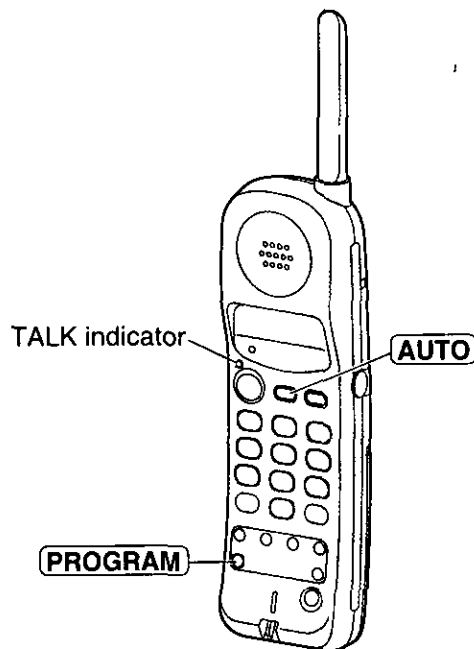

To erase a stored number

1. Press **PROGRAM**.
2. Press **AUTO**.
3. Press the memory station number (0 to 9) you want to erase.
 - 1 beep sounds and erasing is completed.

Making a voice call with the handset using stored numbers =====

- 1** Press **TALK**.
 - The TALK indicator will light.
- 2** Press **AUTO**.
- 3** Press the desired memory station number (0 to 9).
 - The stored telephone number will be dialed.
- 4** When finished talking, press **TALK**.
 - The TALK indicator will turn off.

Note:

- Numbers stored in the handset cannot be accessed by the main unit.
- For further details for handset operation, see page 33.

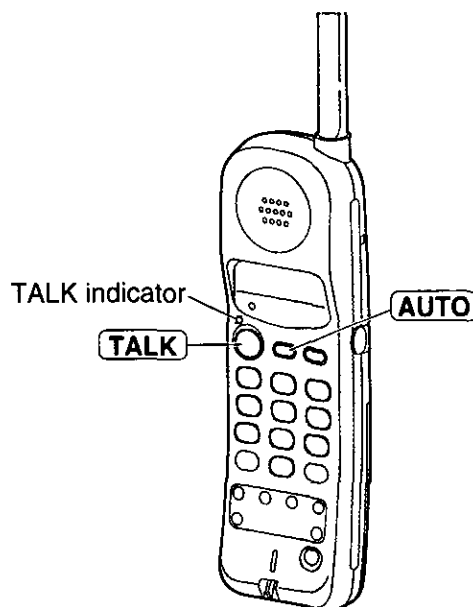

Automatic Dialing (Handset)

Storing a telephone number in the DIRECT button

You can store a telephone number in the **DIRECT** button. The stored number is dialed with a one-touch operation.

The **TALK** indicator light must be off before programming.

- 1** Press **PROGRAM**.
 - The **TALK** indicator will flash.
- 2** Enter a telephone number up to 22 digits.
 - If you misdial, press **PROGRAM** to end storing, then start from step 1.
- 3** Press **DIRECT**.
 - A beep sounds.

Note:

- If a pause is required for dialing, press **REDIAL/PAUSE** where needed. Pressing **REDIAL/PAUSE** counts as one digit.

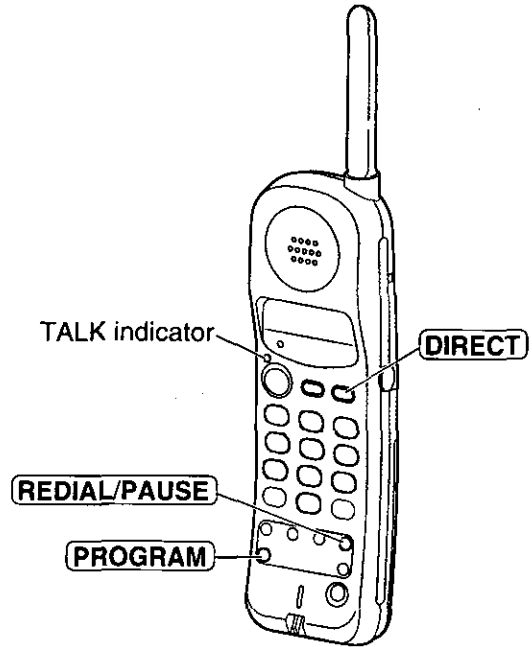

To erase a stored number

1. Press **PROGRAM**.
2. Press **DIRECT** for the telephone number to be erased.

Dialing a stored number in the DIRECT button

- 1** Press **TALK**.
- 2** Press **DIRECT**.
 - The stored telephone number will be dialed.

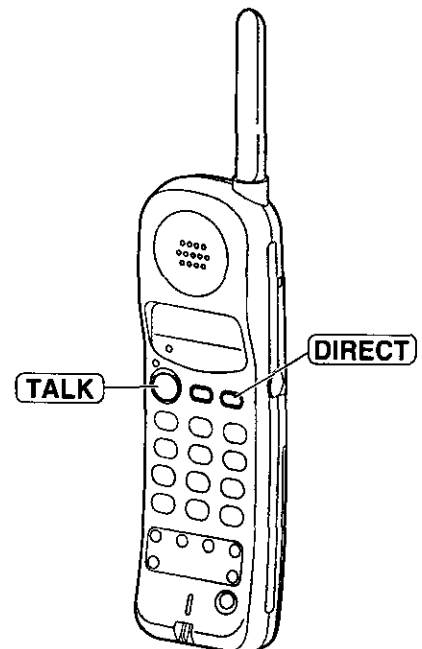

Storing names and telephone numbers in the One-Touch Dial

The unit's memory allows you to use the One-Touch Dial for rapid access to your most frequently dialed numbers. 6 stations are available.

- One-Touch Dial keys 1, 2 or 3 can be used as One-Touch Dial keys (DIAL MODE) or as broadcast keys (BROADCAST). These functions cannot be used at the same time. For the broadcast function, see pages 64 to 66.

- Press **DIRECTORY PROGRAM**.

Display: PRESS STATION

↑

OR USE JOG-DIAL
- For stations 1-3
Press one of the One-Touch Dial keys.

DIAL MODE ▼▲

Press **START/SET/COPY** to go to the next prompt.

For stations 4-6
Press **LOWER**, then press one of the One-Touch Dial keys.
- Enter the station name, up to 10 characters, following the instructions on page 27.

Example: NAME=John
- Press **START/SET/COPY**.

Example: <S02>=
- Enter the telephone number up to 30 digits.

 - To enter a hyphen in a telephone number, press **HYPHEN** (One-Touch Dial key 1).

Example: <S02>=111-4497
- Press **START/SET/COPY**.

REGISTERED

↓

PRESS STATION

↑

OR USE JOG-DIAL

 - To program other stations, repeat steps 2 to 6.
- Press **DIRECTORY PROGRAM** to exit the program.

Helpful hint:

- You can confirm the stored items on the display (p. 45) or on the telephone number list (p. 109).

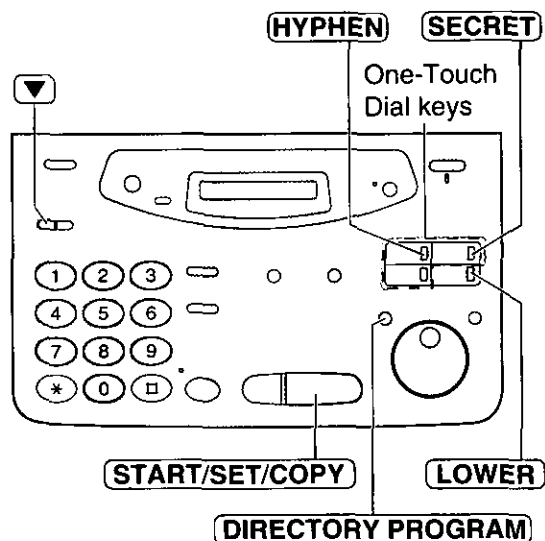

Note:

- If "DIAL MODE" is not displayed when you select stations 1, 2 or 3 in step 2, the broadcast function has been set. To use the station as a One-Touch Dial key, press ▼ to select "DIAL MODE". The broadcast function will be canceled.
- A hyphen entered in a telephone number counts as two digits.

To keep the telephone number secret

Press **SECRET** (One-Touch Dial key 3) after entering the telephone number in step 5.

- A secret number cannot be viewed after this is set.
- The telephone number will not appear on the telephone number list.
- Pressing **SECRET** does not count as a digit.

To edit a stored station name and number

Enter the desired name in step 3.

Enter the desired number in step 5.

To erase a stored station name and number, see page 44.

One-Touch Dial

Making a voice call using the One-Touch Dial

Before using this feature, program the desired names and telephone numbers into the One-Touch Dial (p. 41).

- 1** Press **MONITOR** on the main unit.

Display:

- Check that there are no documents in the document feeder tray.

- 2** For stations 1–3
Press the desired One-Touch Dial key.

For stations 4–6
Press **LOWER**, then press the desired One-Touch Dial key.

Example:

- 3** When the other party answers, lift the handset and speak with the handset.

- 4** When finished talking, press **TALK** or replace the handset.

Helpful hints:

- You can confirm the stored items on the display (p. 45) or on the telephone number list (p. 109).
- You can use the JOG DIAL directory to select the station name instead of using the One-Touch Dial keys. Rotate **JOG DIAL** until the desired name is displayed, then press **MONITOR** or lift the handset.

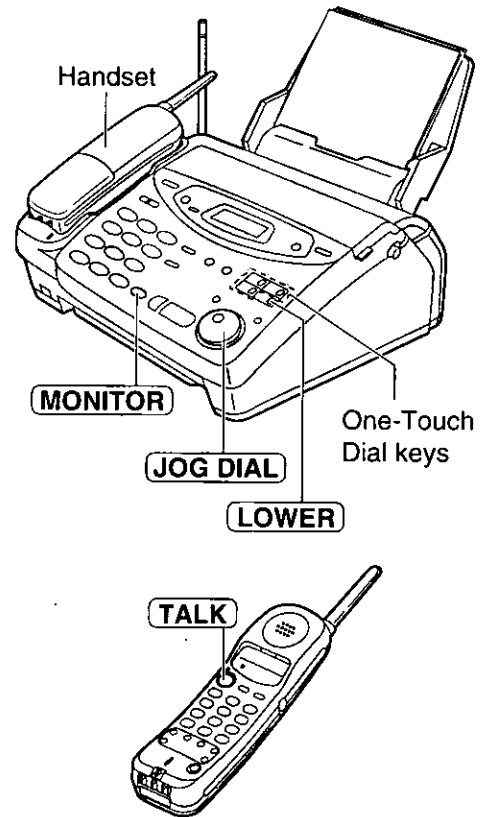

Storing names and telephone numbers in the JOG DIAL directory

For rapid access to frequently dialed numbers, the unit also provides a JOG DIAL directory (100 stations) in addition to the One-Touch Dial. For your convenience, the following 2 stations have been pre-programmed in the JOG DIAL directory.

HELP-FAX (1-800-435-7329): If you cannot correct a problem after trying the help function (p. 17), call using this station (p. 45).

IQ-FAX-CS (IQ-FAX Customer Service Center) (1-888-332-9728): If you have a problem with IQ-FAX, call using this station (p. 45).

If you do not need the above stations, you can edit or erase them (p. 44).

1 Press **DIRECTORY PROGRAM**.

Display:

↑

2 Rotate **JOG DIAL** until the following is displayed.

3 Enter the name, up to 10 characters, following the instructions on page 27.

Example:

4 Press **START/SET/COPY**.

5 Enter the telephone number up to 30 digits using the dial keypad.

Example:

- If you want to enter a hyphen, press **HYPHEN**.

6 Press **START/SET/COPY**.

↓

- To program other items, repeat steps 3 to 6.

7 Press **DIRECTORY PROGRAM** to exit the program.

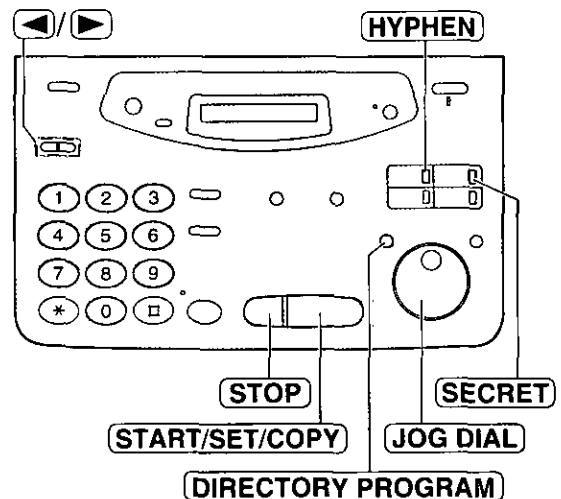

Helpful hint:

- You can confirm the stored items on the display (p. 45) or on the telephone number list (p. 109).

Note:

- You can store items during a telephone conversation.
- When the following message is displayed in step 6, you can only store 5 more items.

Display:

- If the unit shows "JOG-DIAL FULL" in step 1, there is no space to store new stations. Erase unnecessary stations (p. 44).
- A hyphen entered in a telephone number counts as two digits.

To correct a mistake

- Press **◀** or **▶** to move the cursor to the incorrect character, and make the correction.

To delete a character or number

- Move the cursor to the character or number you want to delete and press **STOP**.

To keep the telephone number secret

Press **SECRET** (One-Touch Dial key 3) after entering the telephone number in step 5.

- A secret number cannot be viewed after this is set.
- The telephone number will not appear on the telephone number list.
- Pressing **SECRET** does not count as a digit.

JOG DIAL

Editing a stored name and number

- 1** Rotate **JOG DIAL** until the desired name is displayed.

Example:

- 2** Press **DIRECTORY PROGRAM**.

- 3** Press ***** to select "EDIT".

- If you do not need to edit the name, go to step 5.

- 4** Edit the name by following the instructions on page 27.

- 5** Press **START/SET/COPY**.

Example:

- If you do not need to edit the telephone number, go to step 7.

- 6** Edit the telephone number. For further details, see page 43.

- 7** Press **START/SET/COPY**.

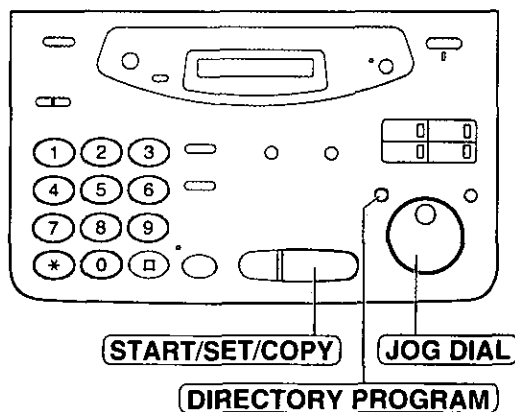

Erasing a stored name and number

You can also erase a name and number stored in the JOG DIAL directory or One-Touch Dial.

- 1** Rotate **JOG DIAL** until the desired name is displayed.

Example:

- 2** Press **DIRECTORY PROGRAM**.

- 3** Press **#** to select "DELETE".



- If you do not want to erase the item, press **STOP**.

- 4** Press **START/SET/COPY**.

- The stored name and number are deleted.

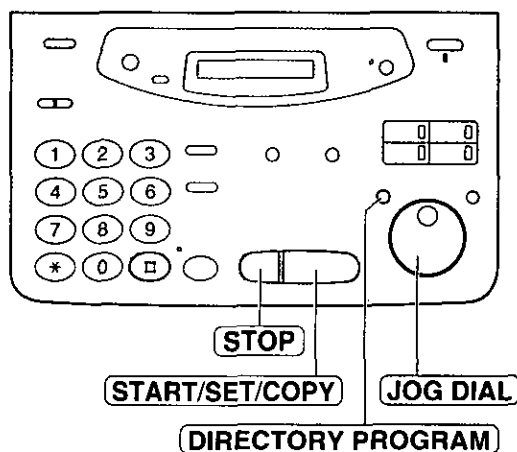

Making a voice call using the JOG DIAL directory

Before using this feature, program the desired names and telephone numbers into the directory (p. 43).

- 1 Rotate **JOG DIAL** until the desired name is displayed.

Example:

- 2 ■ **Handset is off the main unit:**
Press **TALK** on the handset.

- **Handset is on the main unit:**
Press **MONITOR** or lift the handset.
- The unit will start dialing automatically.

- 3 When the other party answers, speak with the handset.

Example:

- 4 When finished talking, replace the handset or press **TALK**.

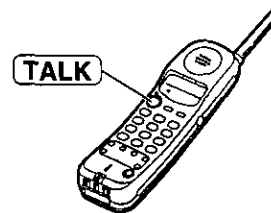
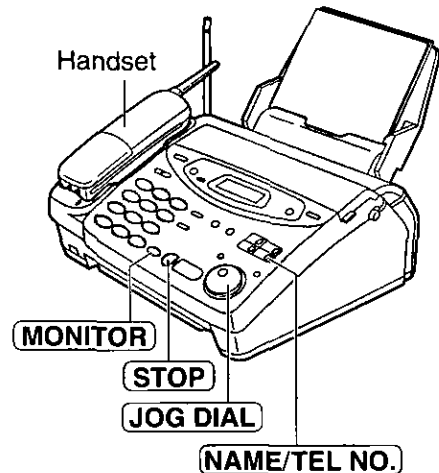

Telephone

Helpful hint:

- You can confirm the stored items on the display (see below) or on the telephone number list (p. 109).

Note:

- If the desired name has not been stored, press **STOP** and dial the number manually.

To confirm the stored items on the display

1. Rotate **JOG DIAL** until the desired name is displayed.

Example:

2. Press **NAME/TEL NO.**.

- To stop the operation, press **STOP**.

3. **Handset is off the main unit:**

Press **TALK** on the handset.

Handset is on the main unit:

Press **MONITOR** or lift the handset.

- The unit will automatically dial the number.

To search for a name by initial

Example: If you want to search for the name "Lisa"

1. Rotate **JOG DIAL** until any name is displayed.

Example:

2. Press **5** repeatedly until any name with the initial "L" is displayed (see the character table on page 27).

3. Rotate **JOG DIAL** to the right until "Lisa" is displayed.

- To stop the operation, press **STOP**.

4. **Handset is off the main unit:**

Press **TALK** on the handset.

Handset is on the main unit:

Press **MONITOR** or lift the handset.

- The unit will automatically dial the number.

Note:

- If you want to search for symbols (not letters or numbers), press ***** in step 2.

Caller ID

Caller ID service from your phone company

This unit is compatible with a Caller ID service offered by your local telephone company. To use this feature, you must subscribe to a Caller ID service.

Caller ID and its capabilities

Caller ID allows you to view the name or telephone number of the caller before you answer the call. The calling party information (name has priority) will be displayed after the first ring.

By using Caller ID, you have the option of whether or not to answer the call depending on the caller.

The unit also stores the caller's information and prints a list automatically after every 35 calls (p. 51).

- To print out the Caller ID list manually, see page 109.

Important:

- When you subscribe to a Caller ID service, set the following ring count settings to 2 or more rings:
 - FAX ONLY mode ring count (p. 72), and
 - TEL/FAX delayed ring count (p. 81).

How Caller ID is displayed

- 1 When a call is received, the display will show the caller's name after the first ring.

Example:

- 2 You can display the caller's name and number respectively by pressing .

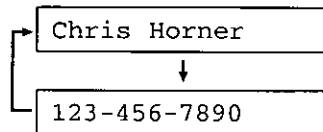

- 3 After hanging up, the caller's information (name, telephone number and the time of the call) will automatically be saved in the Caller ID list (p. 51).

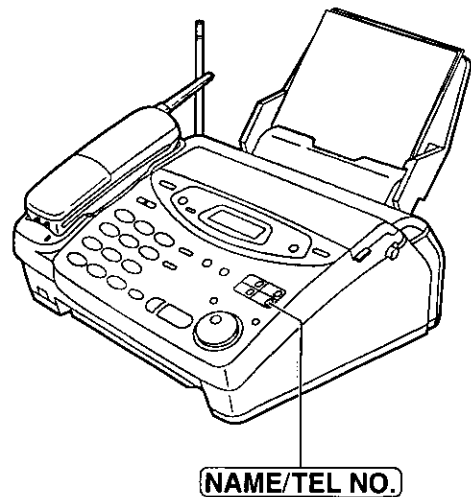

Note:

- If the unit is connected to a PBX system, you may not receive the caller's information. Consult your PBX supplier.
- The Caller ID service is currently provided in calling areas by caller identification technology. If the caller's information cannot be received, the display will show as follows.

Display: <input type="text" value="OUT OF AREA"/>	The caller dialed from an area which does not provide the Caller ID service.
<input type="text" value="PRIVATE CALLER"/>	The caller has requested not to send their information.
<input type="text" value="LONG DISTANCE"/>	The caller made a long distance call.

Viewing the Caller ID list on the display

The unit stores the caller's information and makes a list of up to 35 callers in chronological order. When the memory is full and the unit receives a new call, the oldest data will automatically be erased.

With the Caller ID list, the following convenient features are available.

- Viewing who has called you on the display (See below)
- Dialing a telephone number from the list (p. 48)
- Storing a telephone number for automatic dialing from the list (p. 49)
- Printing out a Caller ID list (p. 109)

1 Press **CALLER ID SEARCH**.

Example: 2 NEW CALLS



Display: USE JOG-DIAL

2 Rotate **JOG DIAL** to search the Caller ID list (see below).

3 If you want to know the caller's phone number and the date/time of the call, press **NAME/TEL NO.** repeatedly while the display is showing the desired name.

- The display will alternate the name, number and date/time when you press **NAME/TEL NO.**

WENDY ROBERTS



345-3809



Mar. 14 02:30PM

4 Press **STOP** to exit the Caller ID list.

Display: NO NAME RCVD

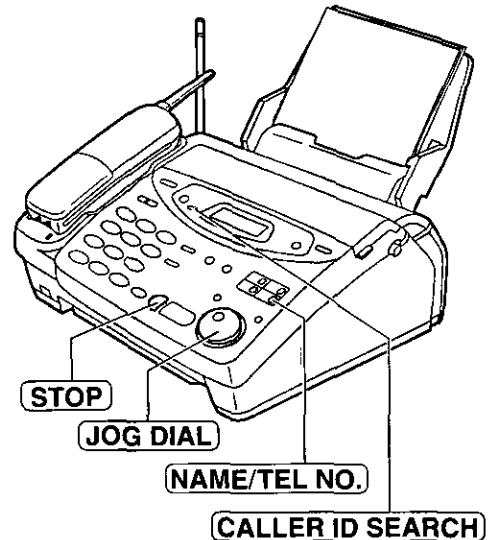

Telephone

Note:

- If the caller's name and number cannot be received, the following message will be displayed.

Ex. When you search from the most recent call/oldest call

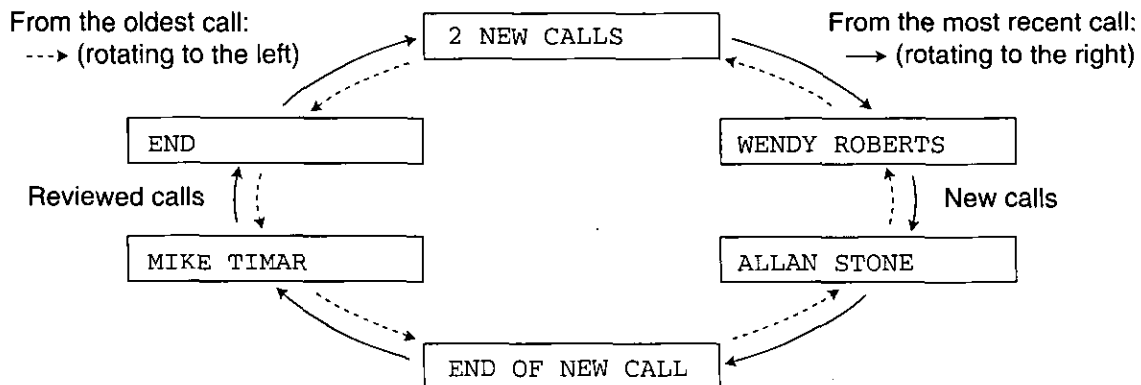

Note:

- To move between calls, rotate **JOG DIAL**.
- The display will show "END OF NEW CALL" after the last new call in the list.
- The display will show "END" after the last call in the list.
- If the display shows "NO CALLER DATA" and a beep sounds, the Caller ID list is empty.

Caller ID

Calling back from the Caller ID list

You can easily call back a telephone number recorded in the Caller ID list.

Important:

- This feature is not available in the following cases.
 - The telephone number includes data other than numbers (e.g. * or #).
 - The telephone number information was not received.

1 Press **CALLER ID SEARCH**.

Example:

Display:

2 Rotate **JOG DIAL** until the desired name or telephone number is displayed.

Example:

3 ■ **Handset is off the main unit:**

Press **TALK** on the handset.

■ **Handset is on the main unit:**

Press **MONITOR** or lift the handset.

- The unit will automatically dial the number.

4 When finished talking, replace the handset or press **TALK**.

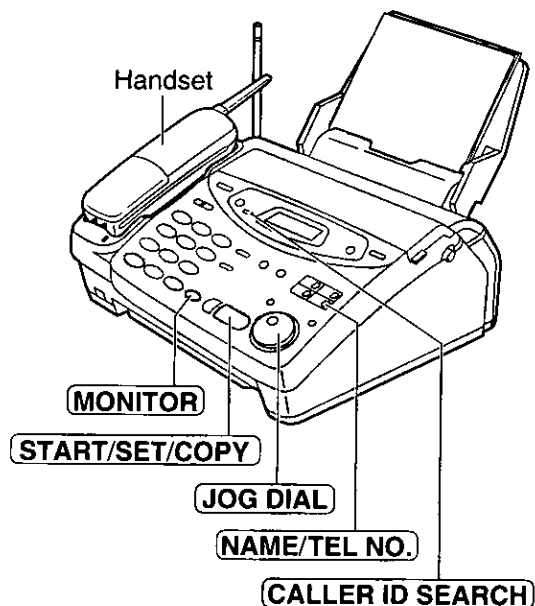

Note:

- You can send a fax by pressing **START/SET/COPY** after step 3. Make sure document is on the document feeder tray.
- If a telephone number is not displayed when pressing **NAME/TEL NO.**, you cannot call back that caller.

To edit 10 digit telephone numbers into one of 4 patterns on the main unit

Press ***** in step 2 to select a pattern.

Each time you press *****, the number will be arranged into one of 4 different patterns.

a:

b: 1- -

c: 1-

d: -

Storing telephone numbers in the One-Touch Dial and JOG DIAL directory from the Caller ID list

You can store names and telephone numbers in the One-Touch Dial and JOG DIAL directory from the Caller ID list.

Important:

- This feature is not available in the following cases.
 - The telephone number includes data other than numbers (e.g. * or #).
 - The telephone number information was not received.

1 Press **CALLER ID SEARCH**.

Example: 2 NEW CALLS

↓

Display: USE JOG-DIAL

2 Rotate **JOG DIAL** until the name you want to store is displayed.

Example: WENDY ROBERTS

3 Press **DIRECTORY PROGRAM**.

PRESS STATION

↓

OR USE JOG-DIAL

4 a: To store in the One-Touch Dial memory:
For stations 1–3, press one of the One-Touch Dial keys.

DIAL MODE ▼▲

Press **START/SET/COPY**.

Example: NAME=WENDY ROBE

Press **START/SET/COPY**.

<S02>1233453809

For stations 4–6, press **LOWER**, then press one of the One-Touch Dial keys.

Example: NAME=WENDY ROBE

Press **START/SET/COPY**.

<S06>1233453809

- A new entry will overwrite any previous information.
- If you are using One-Touch Dial keys 1, 2 or 3 as BROADCAST keys (p. 64), One-Touch Dial keys cannot be used for this feature.
- You can only store a name up to 10 characters long. To edit the name and number, see the instructions on page 41.

b: To store in the JOG DIAL directory:
Rotate **JOG DIAL**.

Example: NAME=WENDY ROBE

Press **START/SET/COPY**.

NO.=1233453809

- If the directory is full, a name and number cannot be stored.
- You can only store a name up to 10 characters long. To edit the name and number, see the instructions on page 44.

5 Press **START/SET/COPY**.

REGISTERED

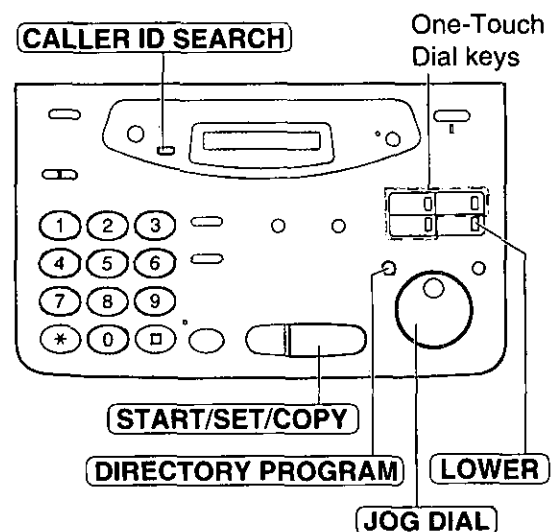

Note:

- You cannot store caller information in the One-Touch Dial and JOG DIAL directory if a telephone number is not displayed.

Erasing all callers' information

You can erase all of the entries in the Caller ID list.

1 Press **MENU** three times.
Display: 3.CALLER SET UP

2 Press **START/SET/COPY**.
PRESS [▼▲] & [SET]

3 Press ▼ or ▲ until the following message is displayed.
CALL LIST ERASE

4 Press **START/SET/COPY**.
ALL ERASE OK?

- If you do not want to erase the information, press **STOP**.

5 Press **START/SET/COPY**.
ERASE COMPLETED

6 Press **STOP** to exit the program.

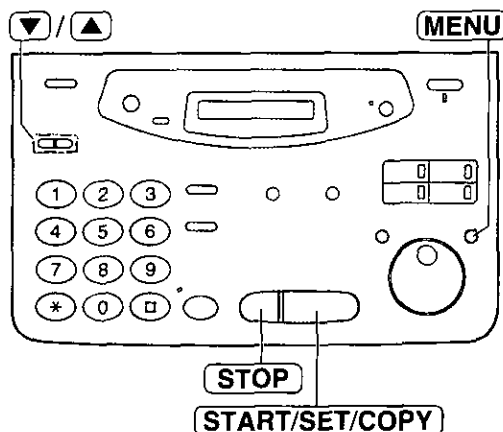

Storing your area code

When this feature is set, the caller's telephone number will be displayed without the area code when a call is received from the same area. If the call is received from outside your area, the telephone number will be displayed with "1" at the beginning.

1 Press **MENU** three times.
Display: 3.CALLER SET UP

2 Press **START/SET/COPY**.
PRESS [▼▲] & [SET]

3 Press ▼ or ▲ until the following message is displayed.
AREA CODE

4 Press **START/SET/COPY**.
CODE=

5 Enter your area code using 3 digits on the dial keypad.

6 Press **START/SET/COPY**.
REGISTERED

7 Press **STOP** to exit the program.

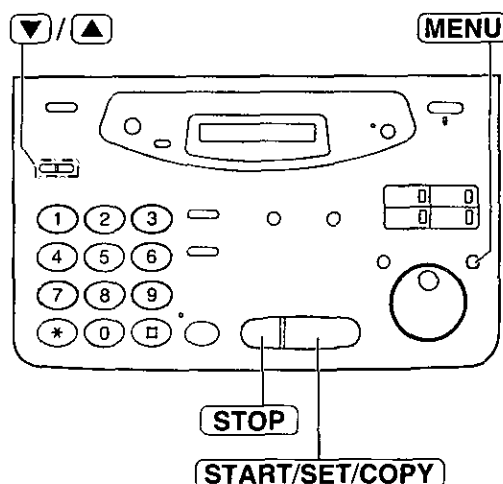

To erase the area code

- Press **STOP** when your area code is displayed in step 4. Press **START/SET/COPY**. Press **STOP** to exit the program.

Automatic Caller ID list

This feature will print a Caller ID list automatically after every 35 new calls.

After printing, only the oldest caller information will be erased when a new call is received.

When this feature is turned off, the unit will store the records of caller information, but will not print the Caller ID list automatically.

1 Press **MENU**.
Display: 1.SYSTEM SET UP

2 Press **□**, then **2 6**.
AUTO CALL. LIST

3 Press **START/SET/COPY**.
MODE=ON ▼▲

4 Press ▼ or ▲ to select the desired setting.
• If this feature is not required select "OFF".

5 Press **START/SET/COPY**.
SETUP ITEM []

6 Press **MENU**.

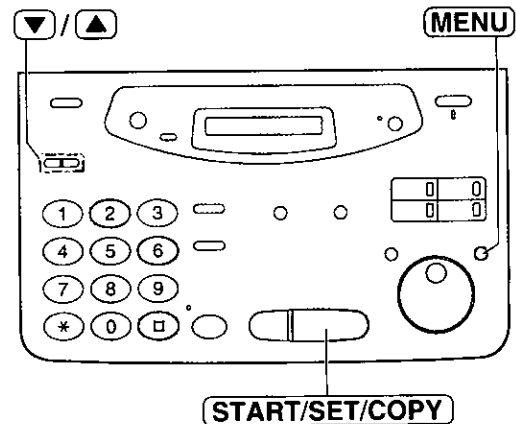

Sample of a Caller ID list

CALLER ID LIST				
				Jan. 04 1999 04:37PM
[NEW]				
NO.	NAME	TELEPHONE NUMBER	TIME OF CALL	ANSWER
01	WENDY ROBERTS	123-345-3809	Jan. 04 02:35PM	FAX
02	ALLAN STONE	456-103-2238	Jan. 03 08:35AM	TEL
[OLD]				
NO.	NAME	TELEPHONE NUMBER	TIME OF CALL	ANSWER
01	MIKE TIMAR	789-345-1029	Jan. 01 02:35PM	TEL

- The NAME/TELEPHONE NUMBER/TIME OF CALL information is received through a Caller ID service (p. 46).
- ANSWER: How the call was received by the unit.
 - FAX: Facsimile
 - TEL: Telephone
 If the unit did not respond to the call, the ANSWER column will be blank.
- You can also print a Caller ID list manually (p. 109).

Voice Contact

Talking to the caller after fax transmission or reception

You can talk to the other party on the same call after a fax message is completed. This will save the added expense and time of making another call.

This feature only works when the other party's fax machine is equipped with a voice contact feature.

Initiating voice contact

- 1 Press **MONITOR** while transmitting or receiving documents.

Display: **VOICE STANDBY**

- Your unit will call the other party with a distinctive ring.
- When the other party answers, your unit will emit a distinctive ring.

- 2 To start talking, press **TALK** on the handset or lift the handset from the main unit.

Note:

- If you initiate voice contact during transmission, the unit will call you with a distinctive ring after all of the documents have been transmitted.
- If you initiate voice contact during reception, the unit will call you with a distinctive ring after the current page of the document is received.

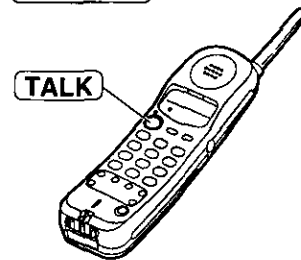
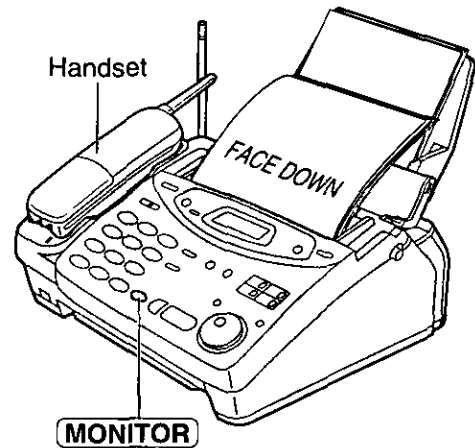

Receiving a request for voice contact

- 1 If the other party initiates voice contact, your unit will sound a distinctive ring and the following will be displayed.

Display: **PLEASE PICK UP**

- 2 To start talking, press **TALK** on the handset or lift the handset from the main unit within 10 seconds of the distinctive ring.

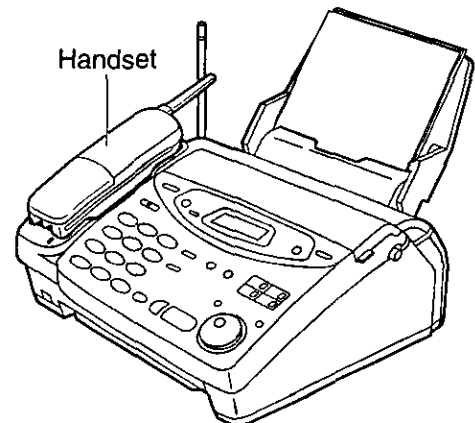

Sending a fax manually

- 1** Open the document feeder tray.
- 2** Adjust the width of the document guides to the size of the document.
- 3** Insert the document (up to 15 pages) **FACE DOWN** until a single beep is heard and the unit grabs the document.

Display: STANDARD

- 4** If necessary, press **RESOLUTION** repeatedly to select the desired setting (see below).
- 5** Press **MONITOR** on the main unit. (This step is optional. See note.)

TEL=

- 6** Dial the fax number.

Example: TEL=5678901

- 7** When a fax tone is heard:
Press **START/SET/COPY**.
OR

When the other party answers your call:

Lift the handset if using the monitor and ask them to press their start button. When a fax tone is heard, press **START/SET/COPY** and replace the handset.

CONNECTING

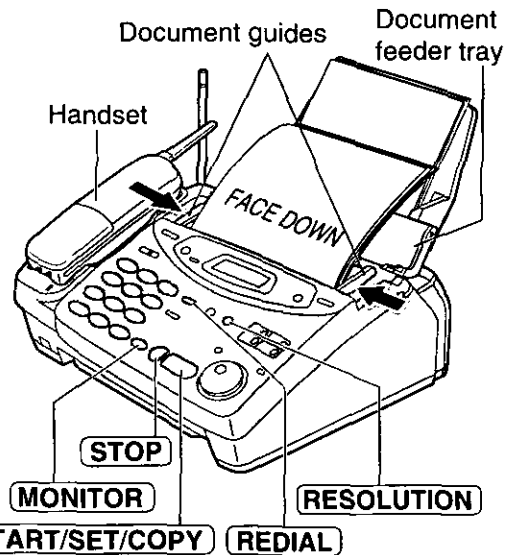

Note:

- If you cannot send a fax, check the problem by printing a journal report (p. 109) and see page 90 to solve the problem.
- Performing step 5 allows you to identify any possible problems in sending a fax. For the parties with whom you have experienced no problems, you can skip step 5. Dial the fax number and press **START/SET/COPY**.

Fax/Copy

To feed more than 15 pages at a time

Insert the first 15 pages of the document. Add the extra pages (up to 15) before the last page is fed into the unit.

To redial the last number

Regardless of whether the main unit or the handset was used, the last number dialed will be redialed. Press **REDIAL**.

- If the line is busy, the unit will automatically redial the number up to 5 times.
- During redial, the following will be displayed.

Display: WAITING REDIAL

- To cancel redialing, press **STOP**.

To stop transmission

Press **STOP**.

To eject the document, press **STOP** again.

To select the resolution

Select the desired resolution according to the type of document.

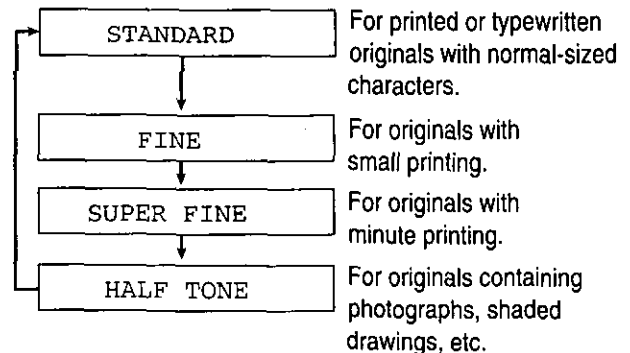

- Using the fine, super fine or half tone setting will increase the transmission time.
- If the resolution setting is changed during feeding, it will be effective from the next sheet.
- The super fine resolution only works with other compatible fax machines.

Sending Faxes

Sending a fax using the One-Touch Dial

Before using this feature, program the desired names and fax numbers into the One-Touch Dial (p. 41).

- 1 Open the document feeder tray.
- 2 Adjust the width of the document guides to the size of the document.
- 3 Insert the document (up to 15 pages) **FACE DOWN** until a single beep is heard and the unit grabs the document.

Display: STANDARD

- 4 If necessary, press **RESOLUTION** repeatedly to select the desired setting (p. 53).
- 5 **For stations 1–3**
Press the desired One-Touch Dial key.
For stations 4–6
Press **LOWER**, then press the desired One-Touch Dial key.

Example: FAX=<John>
↓
CONNECTING.....

- The unit will start transmission.

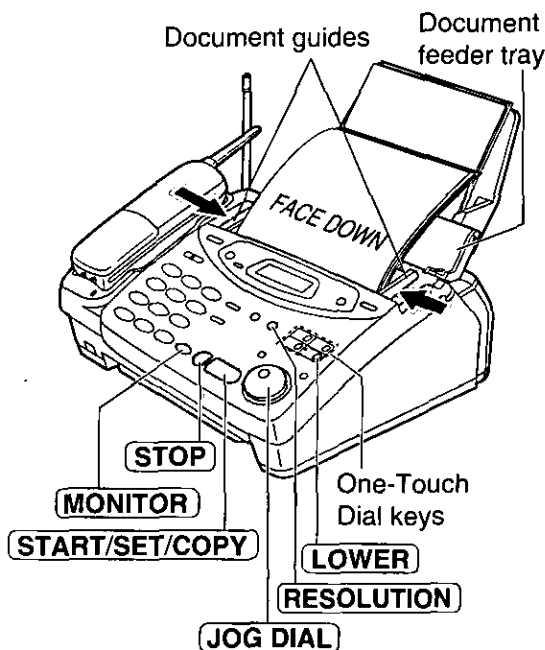

Helpful hints:

- You can confirm the stored items on the display (p. 45) or on the telephone number list (p. 109).
- You can use the JOG DIAL directory to select the station name instead of using the One-Touch Dial keys. Rotate **JOG DIAL** until the desired name is displayed, then press **START/SET/COPY**.
- The connecting tone will be heard during dialing to tell you the status of the other party's machine (p. 67).

If your unit does not send a fax

To verify that the number dialed is answered by the other party's machine:

1. Press **MONITOR**.
2. **For stations 1–3**
Press the desired One-Touch Dial key.

For stations 4–6

Press **LOWER**, then press the desired One-Touch Dial key.

Fax auto redial

If the line is busy or there is no answer, the unit will automatically redial the number up to 5 times.

- This feature is also available for;
 - sending faxes using the JOG DIAL directory (p. 55), and
 - delayed transmission (p. 62).
- During redial, the following will be displayed.

Display: WAITING REDIAL

- To cancel redialing, press **STOP**.

Sending a fax using the JOG DIAL directory

Before using this feature, program the desired names and fax numbers into the directory (p. 43).

- 1 Open the document feeder tray.
- 2 Adjust the width of the document guides to the size of the document.
- 3 Insert the document (up to 15 pages) FACE DOWN until a single beep is heard and the unit grabs the document.

Display:

- 4 If necessary, press **RESOLUTION** repeatedly to select the desired setting (p. 53).
- 5 Rotate **JOG DIAL** until the desired name is displayed.

Example:

- To confirm the number, press **NAME/TEL NO.**

- 6 Press **START/SET/COPY**.

- The unit will start transmission.

Helpful hints:

- You can confirm the stored items on the display (p. 45) or on the telephone number list (p. 109).
- The connecting tone will be heard during dialing to tell you the status of the other party's machine (p. 67).

Note:

- If the desired name has not been stored, press **STOP** and dial the number manually.
- For further details about using the JOG DIAL, see page 45.

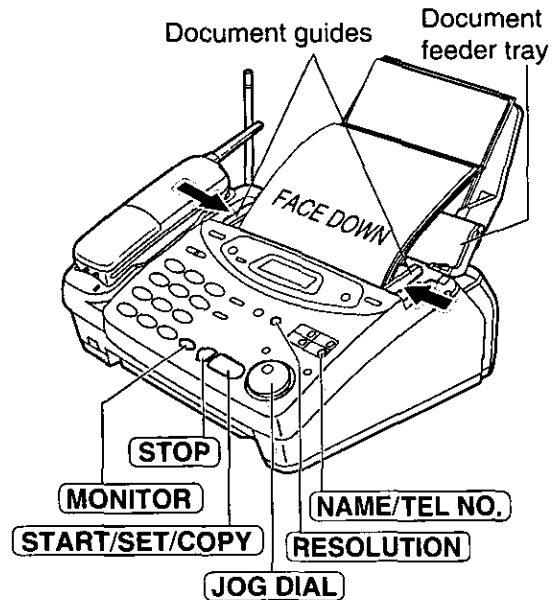

If your unit does not send a fax

To verify that the number dialed is answered by the other party's machine:

1. Rotate **JOG DIAL** until the desired name is displayed.
2. Press **MONITOR**.

Sending Faxes

IQ-FAX

This feature can only be used by those who apply to the FaxSav service.

IQ-FAX is intelligent faxing which allows you to send faxes via the Internet using the IQ-FAX button. Behind the IQ-FAX button is the FaxSav Global Fax Network which manages the delivery of your fax to any fax machine in the world. It routes your fax via the best and most time-efficient route and will automatically resend your fax for you, if the receiving fax machine is unavailable.

This "fax-only" network has the added advantage of cost efficiency due to the Internet being integrated into the network. Every fax is secure since the FaxSav network utilizes the highest encryption legally allowed, ensuring that your document stays secure. You get the benefits of carefree faxing with savings associated with the use of the Internet. It is simple, quick, and secure.

For more information, contact FaxSav at 1-888-332-9728. This number is pre-programmed in the JOG DIAL directory (p. 43).

How your fax is sent to the other party's fax machine

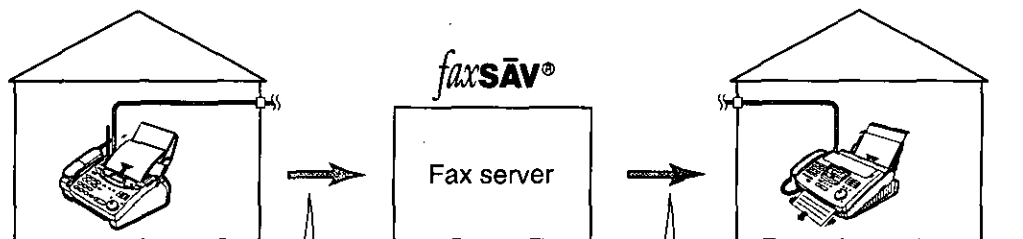

Your unit will send a fax to the fax server.

The fax server will receive the fax from your unit, then send it to the other party's fax machine.

The other party's fax machine will receive the fax from the fax server.

If any transmission errors occur between your unit and the fax server, your unit will automatically redial the fax server up to 2 times.

If any transmission errors occur between the fax server and the other party's fax machine, the fax server will automatically redial the other party's fax machine up to 4 times. If your fax is still not transmitted after 4 attempts, the fax server will fax a Non-Delivery Notice to you. In this case, there is no charge. Set your unit to receive a fax.

How to apply for the FaxSav Internet service for your unit

- 1 Fill out the attached application form and fax it to 1-800-909-6649.
 - The FaxSav company will send you a welcome fax after they have activated your account.
 - There is no application or monthly fee. You pay only for the faxes you send.
- 2 To activate the IQ-FAX function from your fax machine, set feature setting #75 to "ON" (see next page).

Turning on the IQ-FAX function

Before programming, confirm that your application has been processed by FaxSav.

1 Press **MENU**.
Display: 1.SYSTEM SET UP

2 Press **□**, then **7 5**.
IQ-FAX

3 Press **START/SET/COPY**.
MODE=OFF ▼▲

4 Press ▼ or ▲ to select "ON".
MODE=ON ▼▲

● If this feature is not required, select "OFF".

5 Press **START/SET/COPY**.
SETUP ITEM []

6 Press **MENU**.

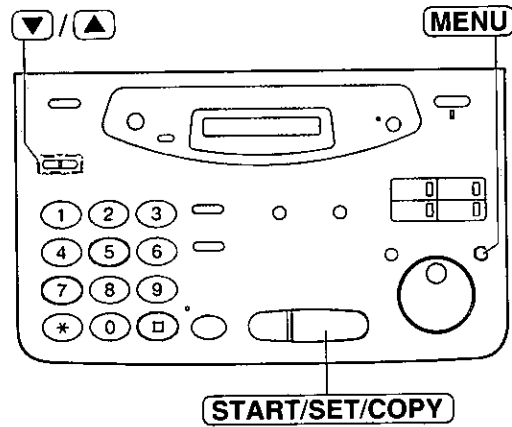

Sending Faxes

Sending a fax using the Internet

- 1 Open the document feeder tray.
- 2 Adjust the width of the document guides to the size of the document.
- 3 Insert the document (up to 15 pages) **FACE DOWN** until a single beep is heard and the unit grabs the document.

Display:

- 4 If necessary, press **RESOLUTION** repeatedly to select the desired setting (p. 53).

- 5 Press **IQ-FAX**.

- 6 Enter the fax number using the dial keypad, One-Touch Dial, **JOG DIAL** or **BROADCAST** key.

- When using the **JOG DIAL**, press **START/SET/COPY** after displaying the desired item.

Example:

- 7 Press **START/SET/COPY**.

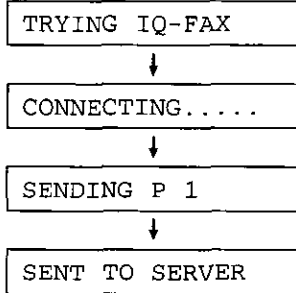

- If the number you dialed is out of the FaxSav network service area, the unit will show the following messages and send the fax directly over the telephone line.

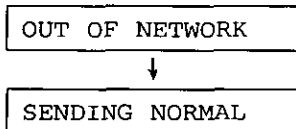

- If "OUT OF NETWORK" is displayed when sending a fax long-distance or internationally using IQ-FAX, then contact FaxSav at 1-888-332-9728.

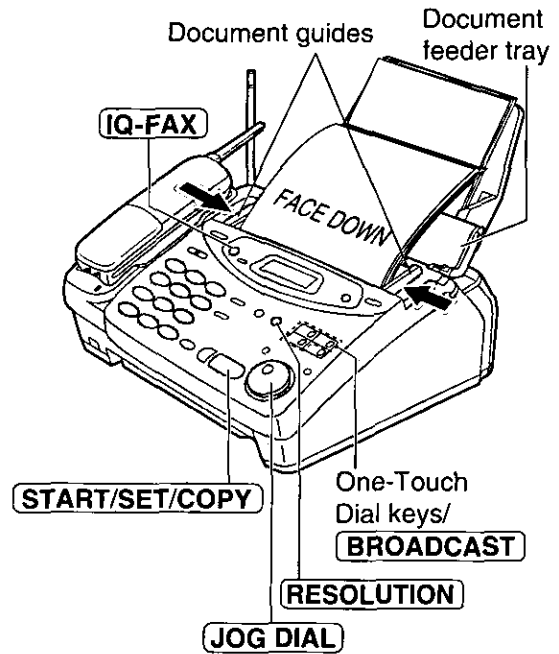

If you cannot send a fax

Contact FaxSav at 1-888-332-9728.

The FaxSav customer service center may send you a program update. While receiving this update, you will not be able to operate the unit and the following message will be displayed for about 3 minutes.

Display:

During this time, you will not be able to operate extension telephones, if they are connected.

If a loading error occurs, the unit will display the following message.

In this case, contact FaxSav at 1-888-332-9728.

Documents you can send

Minimum size

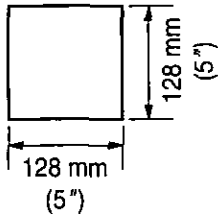

Maximum size

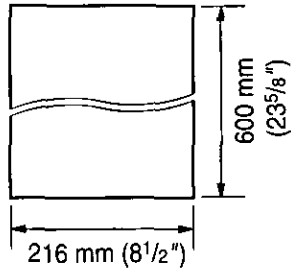

Effective scanning area

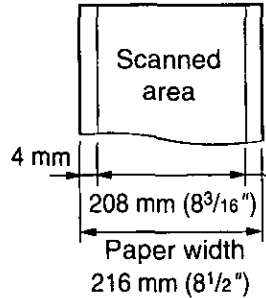

Document weight

Single sheet:
45 g/m² to 90 g/m²
(12 lb. to 24 lb.)

Multiple sheets:
60 g/m² to 75 g/m²
(16 lb. to 20 lb.)

Note:

- Remove clips, staples or other similar fastening objects.
- Check that ink, paste or correction fluid has dried.
- Do not send the following types of documents. Use copies for fax transmission.
 - Chemically treated paper such as carbon or carbonless duplicating paper
 - Electrostatically charged paper
 - Heavily curled, creased or torn paper
 - Paper with a coated surface
 - Paper with a faint image
 - Paper with printing on the opposite side that can be seen through the front (e.g. newspaper)

Sending Faxes

Sending report for confirmation

The sending report will provide you with a printed record of fax transmission results. One of the following choices is available.

- ERROR:** The sending report will print out only when fax transmission fails (pre-selected setting).
ON: The sending report will always print out, indicating whether fax transmission is successful or not.
OFF: The sending report will not print.

1 Press **MENU**.
Display: 1. SYSTEM SET UP

2 Press **□**, then **0 4**.
SENDING REPORT

3 Press **START/SET/COPY**.
MODE=ERROR ▼▲

4 Press ▼ or ▲ to select the desired setting.

5 Press **START/SET/COPY**.
SETUP ITEM []

6 Press **MENU**.

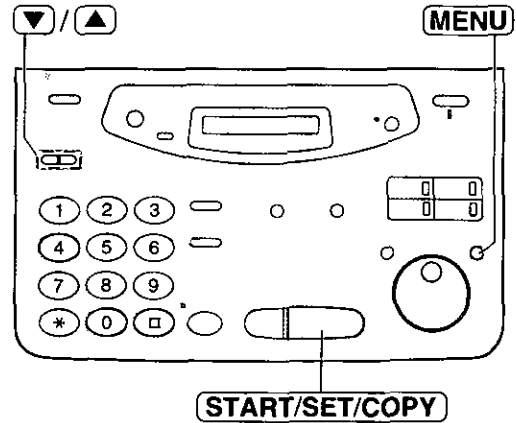

Sample of a sending report

SENDING REPORT		Jan. 20 1999 01:19PM					
NO.	OTHER FACSIMILE	START TIME	USAGE TIME	MODE	PAGES	RESULT	*CODE
01	2345678	Jan. 20 01:18PM	00'51	SND	00	COMMUNICATION ERROR	(43)

SND: Sent directly.
IQ-FAX: Sent to the fax server.

Communication message (p. 90)

Error code (for service personnel use only)

Note:

- If your fax is not transmitted to the other party's fax machine using the FaxSav network, the FaxSav network will send a Non-Delivery Notice to your unit.

Automatic journal report

This feature prints a journal report automatically after every 35 new fax communications. After printing, only the oldest communication result will be erased when a new communication occurs. When this feature is deactivated, the unit will store the records of the fax communications, but will not print the journal report automatically.

- 1 Press **MENU**.
 Display: 1.SYSTEM SET UP
- 2 Press **□**, then **2 2**.
 AUTO JOURNAL
- 3 Press **START/SET/COPY**.
 MODE=ON ▼▲
- 4 Press ▼ or ▲ to select the desired setting.
 • If this feature is not required, select "OFF".
- 5 Press **START/SET/COPY**.
 SETUP ITEM []
- 6 Press **MENU**.

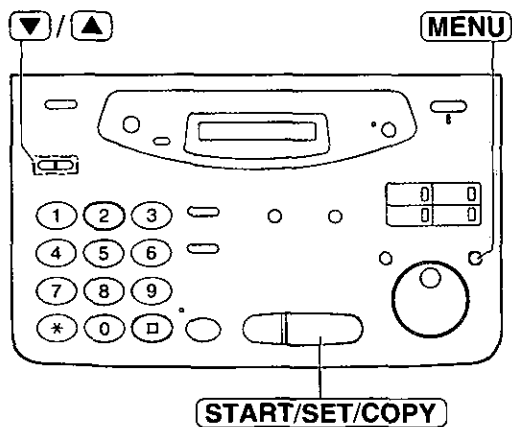

Fax/Copy

Sample of a journal report

JOURNAL							
Jan. 25 1999 05:22PM							
NO.	OTHER FACSIMILE	START TIME	USAGE TIME	MODE	PAGES	RESULT	*CODE
01	3332222	Jan. 21 02:14PM	00'45	SND	01	OK	
02	9998765	Jan. 21 03:17PM	00'58	IQ-FAX	02	OK	
03	John	Jan. 21 05:18PM	00'48	RCV	01	OK	
04	555556677	Jan. 22 10:35AM	02'45	SND	03	COMMUNICATION ERROR	(43)
05			02'50	SND	05	OK	
				RCV	03	OK	

SND: Sent directly.
 IQ-FAX: Sent to the fax server.
 RCV: Received directly.

Communication message (p. 90)

Error code (for service personnel use only)

Note:

- You can also print a journal report manually (p. 109).
- If your fax is not transmitted to the other party's fax machine using the FaxSav network, the FaxSav network will send a Non-Delivery Notice to your unit.

Sending Faxes

Delayed transmission (sending a fax at a specified time)

Using a built-in clock, this unit can send documents automatically at a specified time. This allows you to take advantage of low-cost calling hours offered by your telephone company. The delayed transmission can be set to take place up to 24 hours in advance.

- 1** Insert the document **FACE DOWN** until a single beep is heard and the unit grabs the document.

Display: STANDARD

- 2** Press **MENU**.

1. SYSTEM SET UP

- 3** Press **□**, then **2** **5**.

DELAYED SEND

- 4** Press **START/SET/COPY**.

MODE=OFF ▼▲

- 5** Press ▼ or ▲ to select "ON".

MODE=ON ▼▲

- 6** Press **START/SET/COPY**.

FAX=

- 7** Enter the fax number using the dial keypad, One-Touch Dial or **JOG DIAL**.

- 8** Press **START/SET/COPY**.

TIME=12:00AM

- 9** Enter the transmission start time. Press ***** to select "AM" or "PM".

Example (using the dial keypad): 11:30PM

Press **1** **1** **3** **0**, then press ***** until "PM" is displayed.

TIME=11:30PM

- 10** Press **START/SET/COPY**.

SETUP ITEM []

- 11** Press **MENU**.

SEND AT 11:30PM

- At the programmed time, the unit will automatically start transmission.

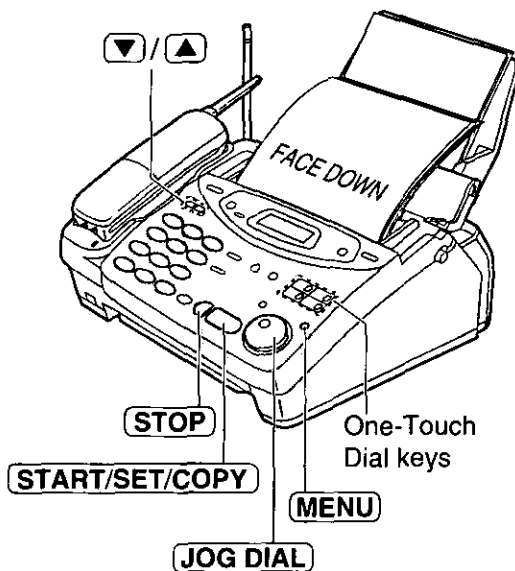

Note:

- You can receive, transmit and copy documents while delayed transmission is set.

To cancel the delayed transmission setting

- 1.** Press **STOP** while the unit is idle.

Display: SEND CANCELED?

YES: PRESS SET

- 2.** Press **START/SET/COPY**.

From memory

The unit is able to scan and store documents into memory, and then transmit the stored document. The memory capacity is approx. 25 pages based on the CCITT No. 1 Test Chart in standard resolution. For the CCITT No. 1 Test Chart, see page 115.

Transmitting document from memory

- 1** Insert the document **FACE DOWN**.
- 2** Enter the fax number using the dial keypad.
- 3** Press **QUICK SCAN**.
 - The document will be fed into the unit and scanned into memory. After storing all of the pages, the unit will transmit the document.
 - The amount of memory used will be shown as a percentage on the display.

Display: PAGES=01 05
Amount of memory used

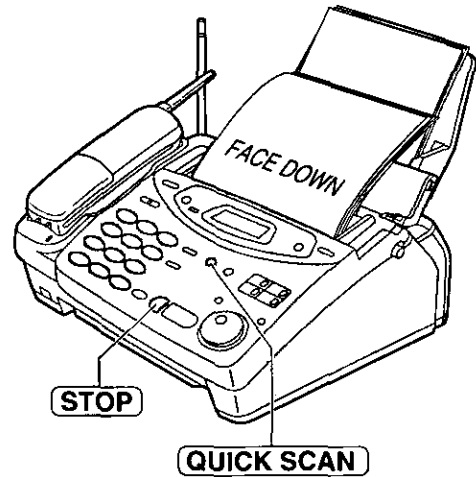

Fax/Copy

Note:

- The stored document will be automatically erased after transmission.
- To cancel the memory transmission, press **STOP** while or after scanning the document.
- If you select the fine, super fine or half tone resolution, the number of documents that can be sent will decrease.
- If the stored pages exceed the memory capacity, the transmission will be canceled.
- If the other party's fax number is written on the document, you can enter the number by referring to the document before inserting it.

Sending Faxes

Multiple stations

This feature is useful for sending the same document to selected parties whose fax numbers are stored in the One-Touch Dial or JOG DIAL directory. You must program the desired parties into one of the BROADCAST keys (One-Touch Dial keys 1, 2 or 3).

Important:

- Before programming, make sure that the desired fax numbers have been stored into the One-Touch Dial or JOG DIAL directory.
- The BROADCAST keys can be used as One-Touch Dial keys 1, 2 or 3 or as broadcast keys. These functions cannot be used at the same time.

Programming the BROADCAST keys with telephone numbers

1 Press **DIRECTORY PROGRAM**.

Display: **PRESS STATION**
↓
OR USE JOG-DIAL

2 Press one of the **BROADCAST** keys.

DIAL MODE ▼▲

3 Press ▼ or ▲ to select "BROADCAST".

Example: **BROADCAST 1** ▼▲

4 Press **START/SET/COPY**.

DIR= [000]

5 Enter the station.

a: Using the One-Touch Dial:

For stations 1–3 which are not used as **BROADCAST** keys, press the preset One-Touch Dial key.

For stations 4–6, press **LOWER**, then press the preset One-Touch Dial key.

Example: **DIR=Luke** [001]

b: Using the JOG DIAL directory:

Rotate **JOG DIAL** until the desired name is displayed.

Example: **John** [001]

Press **START/SET/COPY**.

Example: **DIR=John** [002]

- To enter other stations, repeat this step (up to 20 stations).

6 Press **START/SET/COPY** after entering all of the desired stations.

REGISTERED
↓
PRESS STATION
↓
OR USE JOG-DIAL

- To program another BROADCAST key, repeat steps 2 to 6.

7 Press **DIRECTORY PROGRAM** to exit the program.

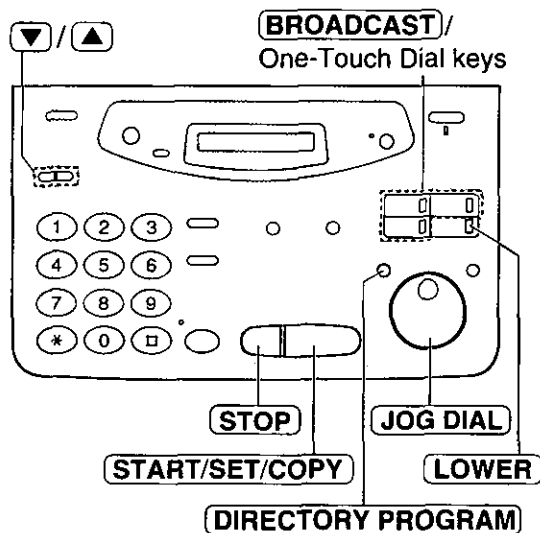

Note:

- If you make a mistake while programming, press **STOP**, and make the correction.
- Confirm the stored numbers by printing a broadcast list (p. 109).

Adding a new name and number

1 Rotate **JOG DIAL** until the desired BROADCAST key is displayed.

Example: <BROADCAST1>

2 Press **DIRECTORY PROGRAM**.

ADD=* DELETE=#

3 Press ***** to select "ADD".

Example: Alex

4 Rotate **JOG DIAL** until the desired name is displayed.

Example: Jack

5 Press **START/SET/COPY**.

REGISTERED

↓

Example: Mike

- To add other stations, repeat steps 4 and 5 (up to 20 stations).

6 Press **DIRECTORY PROGRAM** to exit the program.

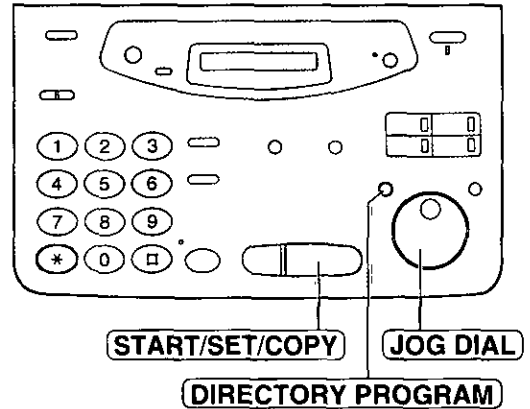

Erasing a stored name and number

1 Rotate **JOG DIAL** until the desired BROADCAST key is displayed.

Example: <BROADCAST1>

2 Press **DIRECTORY PROGRAM**.

ADD=* DELETE=#

3 Press **#** to select "DELETE".

- The first name will be shown.

Example: Bob

4 Rotate **JOG DIAL** until the desired name is displayed.

Example: Dick

- If you do not want to erase the item, press **STOP**.

5 Press **START/SET/COPY**.

DELETE OK?

↓

YES: PRESS SET

6 Press **START/SET/COPY**.

DELETED

↓

Example: Bob

- To delete other stations, repeat steps 4 to 6.

7 Press **DIRECTORY PROGRAM** to exit the program.

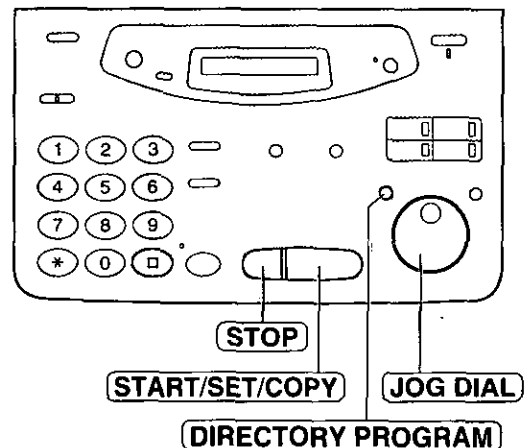

Sending Faxes

Using the BROADCAST keys

The document will be scanned and stored into memory when using the BROADCAST keys. After transmission, the stored document will be erased automatically. The memory capacity is approx. 25 pages based on the CCITT No. 1 Test Chart in standard resolution. For the CCITT No. 1 Test Chart, see page 115.

- 1 Insert the document FACE DOWN.
- 2 Press the desired **BROADCAST** key.
 - The document will be fed into the unit and scanned into memory. The unit will then transmit the data to each station, calling each number sequentially.

Note:

- If you select the fine, super fine or half tone resolution, the number of pages that the unit can transmit will decrease.
- If one of the stations is busy or does not answer, the station will be skipped. All skipped stations will be redialed up to 5 times after all of the other stations have been called.

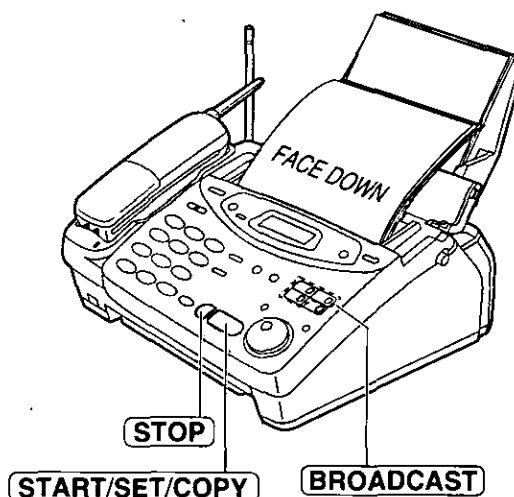

To cancel the broadcast setting

1. Press **STOP** while the unit displays "BROADCASTING".

Display: **SEND CANCELED?**



YES: PRESS SET

2. Press **START/SET/COPY**.

Broadcast report

After all of the transmissions have been completed, the unit will automatically print the following report.

Sample of a broadcast report:

BROADCAST REPORT 1						
Jan. 10 1999 03:36PM						
NO.	OTHER FACSIMILE	START TIME	USAGE TIME	PAGES (IQ-FAX)	RESULT	
01	Mike	Jan. 10 03:31PM	01'10	02 *	OK	
02	Peter	Jan. 10 03:33PM	01'08	02 *	OK	
03	Sam	Jan. 10 03:34PM	01'09	02 *	OK	
04	Kim	Jan. 10 03:35PM	01'10	02 *	OK	
TOTAL			004'37	008 (008)		

Total number of pages sent to the fax server.

The "*" mark in this column shows the fax has been sent to the fax server.

Overseas mode

You may experience difficulty when transmitting documents overseas. This feature makes sending documents easier as the transmission speed is slowed down. Before starting transmission, follow the steps below.

- 1 Press **MENU**.
Display: 1.SYSTEM SET UP
- 2 Press **□**, then **2 3**.
OVERSEAS MODE
- 3 Press **START/SET/COPY**.
MODE=OFF ▼▲
- 4 Press ▼ or ▲ to select "ON".
MODE=ON ▼▲
 - If this feature is not required, select "OFF".
- 5 Press **START/SET/COPY**.
SETUP ITEM []
- 6 Press **MENU**.

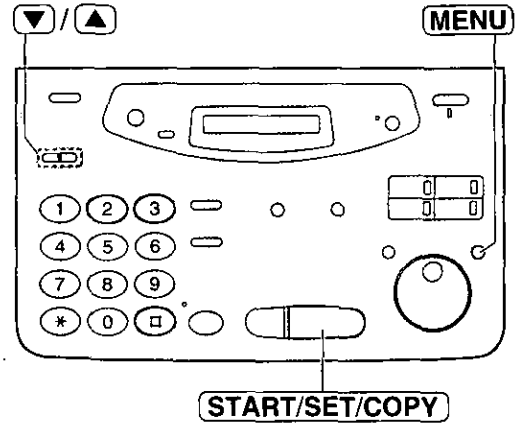

Note:

- After transmission, this feature will turn off automatically.
- This feature is not available for transmission using the BROADCAST keys.
- A slower transmission speed will lengthen the call duration. Therefore the calling charge may be higher.

Fax/Copy

Connecting tone

This feature allows you to hear connecting tones, such as a fax tone, ring back tone or busy tone for several seconds when you send a fax using the One-Touch Dial or JOG DIAL directory. This will tell you the status of the other party's machine.

- Fax tone: The other party's machine is ready for reception.
- Ring back tone: If this tone continues, the other party's machine may not be a facsimile or may have run out of paper. Check with the other party.
- Busy tone: The other party's machine is busy. Let the unit continue redialing or press **STOP** and try again later.

This feature is set to "ON" as a pre-selected setting. If this feature is not required, you may turn it off.

- 1 Press **MENU**.
Display: 1.SYSTEM SET UP
- 2 Press **□**, then **7 6**.
CONNECTING TONE
- 3 Press **START/SET/COPY**.
MODE=ON ▼▲
- 4 Press ▼ or ▲ to select the desired setting.
 - If this feature is not required, select "OFF".
- 5 Press **START/SET/COPY**.
SETUP ITEM []
- 6 Press **MENU**.

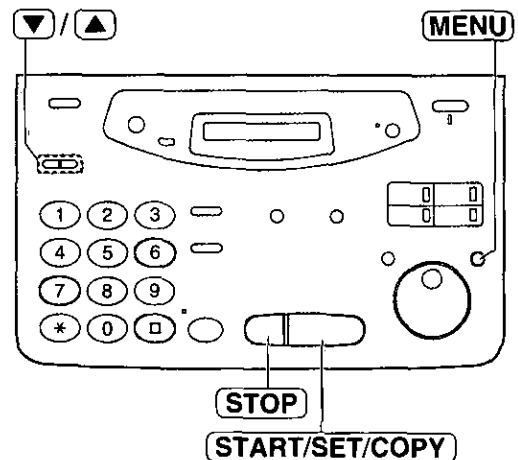

Note:

- The connecting tone volume cannot be adjusted.

Receiving Faxes

Setting the unit to receive calls

Option A

Option B

How you want the unit to receive calls

To answer all voice and fax calls yourself.



Voice/Fax call

You have a separate telephone line just for fax calls.

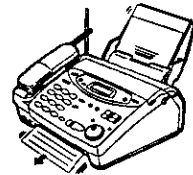

Fax call

You have to set this.

TEL mode

(p. 70)

FAX ONLY mode

(p. 71, 72)

PRE-SELECTED SETTING

The AUTO ANSWER light should be OFF.

- If the AUTO ANSWER light is on, press **AUTO ANSWER** to turn it off.

The AUTO ANSWER light should be ON.

- If the AUTO ANSWER light is off, press **AUTO ANSWER** to turn it on.

This is how the unit will operate.

When the unit rings, you must answer all calls.

- If you hear a fax calling tone (slow beep) or no sound is heard, press **START/SET/COPY**.
- An answering machine can also answer the incoming calls (p. 73).

All incoming calls will be answered as faxes, and the unit will try to receive a fax.

Option C

You have a Distinctive Ring service from the telephone company (this allows you to have up to 3 telephone numbers on the same line).

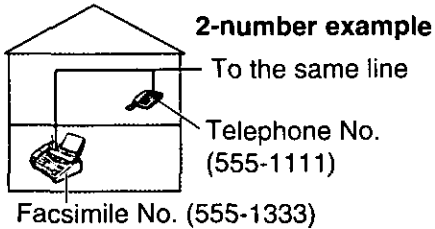

To activate the Distinctive Ring mode, select the same ring pattern assigned to the facsimile number in feature #31 (p. 76, 77).

- A:** Standard ring (one long ring)
- B:** Double ring (two short rings)
- C:** Triple ring (short-long-short rings)
- D:** Other triple ring (short-short-long rings)

The unit will automatically answer calls received at your facsimile number. If a call is received at the other telephone number, the unit will operate based on the set receive mode.

Option D

You want to use the fax machine with an answering machine.

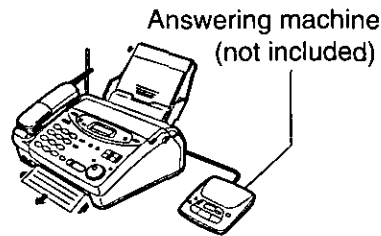

Voice/Fax call

1. Connect an answering machine to the EXT jack.
 2. Set the number of rings on the answering machine to less than 4.
 3. Record a greeting message on the answering machine.
 4. Turn on the answering machine.
 5. Program the remote activation ID into your fax machine.
- For further details, see pages 73 to 75.

Use with TEL mode or FAX ONLY mode.
If you use with FAX ONLY mode, set the FAX ONLY mode ring count to "5 EXT.TAM" (p. 72).

When receiving voice calls:
The answering machine will record voice messages.

When receiving fax calls:
The fax machine will receive document.

Other options

Voice mail
If you have a voice mail service from your telephone company, you also need to subscribe to a Distinctive Ring service (p. 76, 77).

With PC
If you have a computer attached to the same telephone line, see page 74.

TEL/FAX mode
If you are near the unit and want to use it to receive your voice calls yourself and fax calls automatically, see pages 78 to 81.

Remote activation
If you answer a call with the extension telephone and hear the fax tone, you can activate the unit remotely by pressing *9 (p. 82).

Receiving Faxes

TEL mode --- --- (answering all calls manually)

If the AUTO ANSWER light is on, turn it off by pressing

AUTO ANSWER.

Display: TEL MODE

Receiving a fax with the main unit

1 When the unit rings, lift the handset to answer the call.

2 When:
— document reception is required,
— a fax calling tone (slow beep) is heard, or
— no sound is heard,
press **START/SET/COPY**.

CONNECTING.....

3 Replace the handset.
• The unit will start reception.

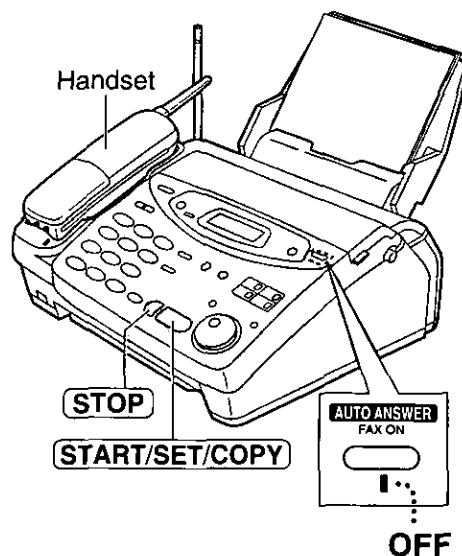

Receiving a fax with the handset

1 When the handset rings, press **TALK**.

2 When:
— document reception is required,
— a fax calling tone (slow beep) is heard, or
— no sound is heard,
press **FAX** until a single beep is heard.
• The only way to stop receiving the fax is by pressing **STOP** on the main unit.

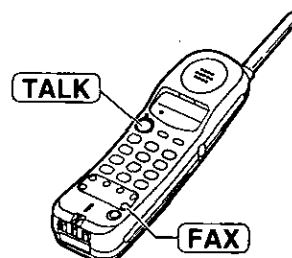

Note:

- If you do not answer the call within 15 rings, the unit will temporarily switch to the fax and the caller can send document.

To stop receiving the document

Press **STOP**.

Friendly reception feature

When you answer a call and hear a fax calling tone (slow beep), the unit will automatically start receiving.

- If this feature is not required, set to "OFF" (p. 85).

Memory reception

When a printing problem is detected, the unit will temporarily store the received document into memory.

While the document is in memory, the unit will:
— display an error message and the following message alternately.

Display: FAX IN MEMORY

— alert you with slow beeps (memory reception alert).

- Follow the instructions on pages 91 and 92 to solve the problem and print the stored document.
- For memory capacity, see page 115.

FAX ONLY mode (all calls are received as faxes)

Activating the FAX ONLY mode

If the AUTO ANSWER light is off, turn it on by pressing **AUTO ANSWER**.

- The display will show the following.

Display: FAX ONLY MODE

- The number of rings before a call is answered can be changed (p. 72).

Note:

- This mode should not be used with a telephone line which is used for both voice and fax calls. When the unit answers the call, fax communication is attempted even if someone is trying to call you.

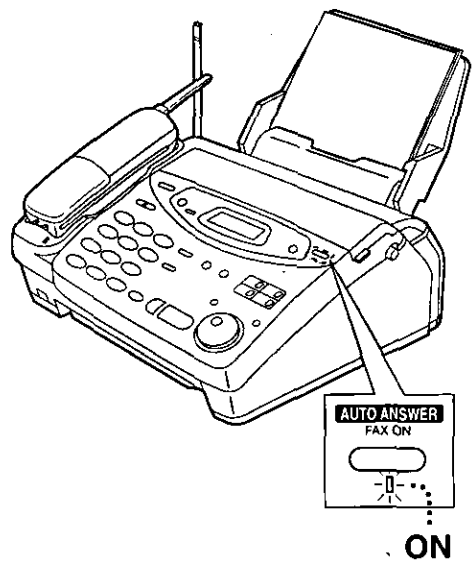

Fax/Copy

If you have a telephone line just for receiving faxes, we recommend the following setup.

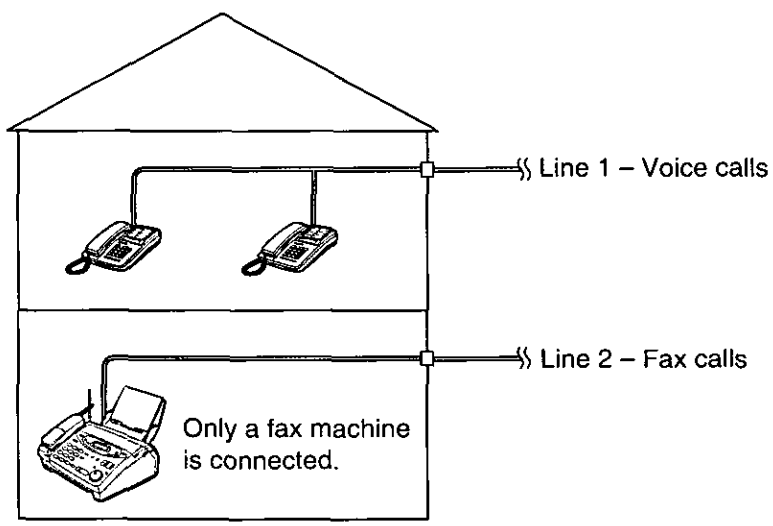

Example: One telephone line is used for voice calls and a separate telephone line for faxes. If someone sends a fax to Line 2, the fax machine will ring.

Receiving Faxes

FAX ONLY mode ring count

This setting determines the number of rings before the unit answers a call in the FAX ONLY mode. You can choose from 1 to 5 rings. If you use the unit with an answering machine, select "5 EXT.TAM" and see pages 73 to 75.

Helpful hints:

- To answer a call before the unit does, increase the number of rings.
- If you have difficulty receiving faxes, the other parties may have tried to send faxes before confirming if your unit answered or not. Decrease the number of rings.

1 Press **MENU**.
Display: 1.SYSTEM SET UP

2 Press **06**, then **06**.
FAX RING COUNT

3 Press **START/SET/COPY**.
RING=2

4 Press **▼** or **▲** to select the desired number, or enter the number using the dial keypad.

5 Press **START/SET/COPY**.
SETUP ITEM []

6 Press **MENU**.

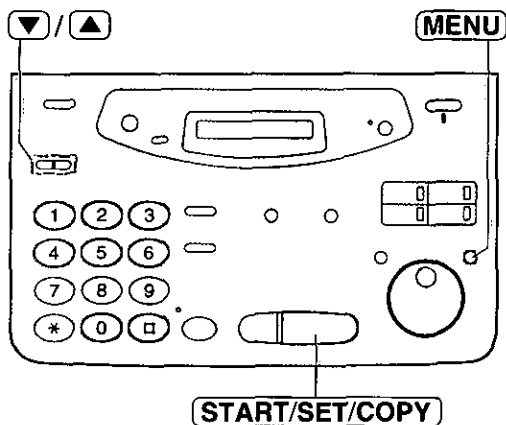

Note:

- If you subscribe to a Caller ID service, set this ring count setting to 2 or more rings.

Using the unit with an answering machine =====

Setting up the fax machine and an answering machine

- 1 Connect the answering machine to the EXT jack on the back of the fax machine.

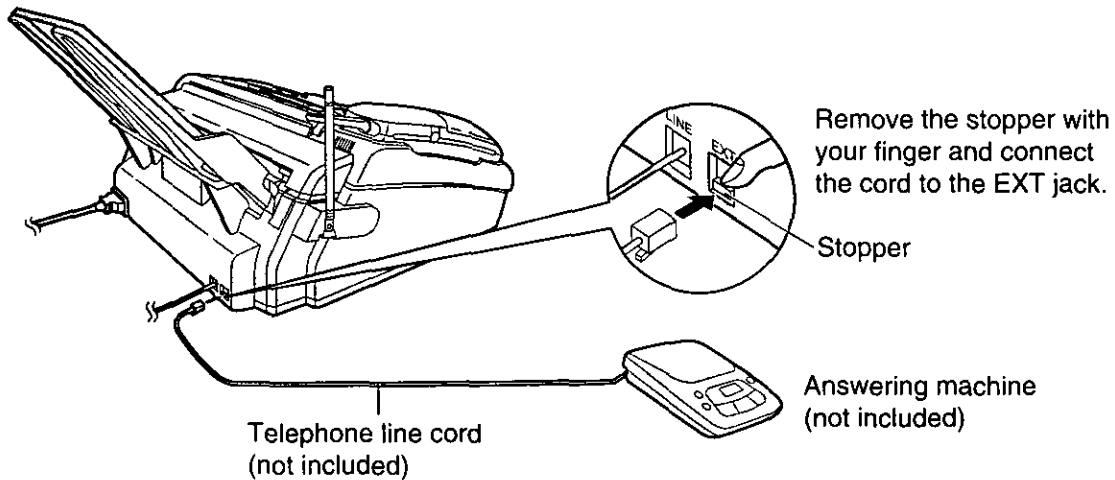

- 2 If you plan to use the FAX ONLY mode on the fax machine, set the number of rings on the answering machine to less than 4.
 - This will allow the answering machine to answer the call first.
- 3 Record a greeting message on the answering machine.

Example: *"This is (your name, business and/or telephone number). We are unable to answer the phone right now. To send a fax, start transmission. To leave a message, please speak after the beep. Thank you."*
- 4 Turn on the answering machine.
- 5 Set the receive mode of the fax machine to the TEL mode (p. 70) or FAX ONLY mode (p. 71).
 - When you set the FAX ONLY mode, **set the ring count in the FAX ONLY mode (feature setting #06) to "5 EXT.TAM"** (p. 72). The number of rings on the answering machine should be less than the FAX ONLY mode ring count so that the answering machine will answer a call first. Using the FAX ONLY mode will allow you to receive faxes if the answering machine is full.
- 6 Check the remote access code of your answering machine and program the same code into the remote operation ID of the fax machine (feature setting #12). See page 75.

Note:

- Do not pause for more than 4 seconds during the greeting message. If a 4-second pause is stored in the greeting message, all incoming calls will be routed to the unit from the answering machine even while the greeting message is playing.
- We recommend you keep the greeting message around 10 seconds long. If the greeting message is too long, some incoming fax calls may not be answered by the fax machine.
- Every time the unit receives a document, a silent pause or fax tone may be recorded on the answering machine.

Receiving Faxes

How the fax machine and answering machine work

Receiving voice calls

The answering machine will record voice messages automatically.

Receiving fax calls

The fax machine will receive document automatically.

Receiving a voice message and fax document in one call

The answering machine will record the voice message first. The fax machine will then be activated by the caller's request and receive the document. For further details, see next page.

To use with an answering machine and computer, we recommend the following setup.

We recommend you use separate wall jacks for the unit and the computer.

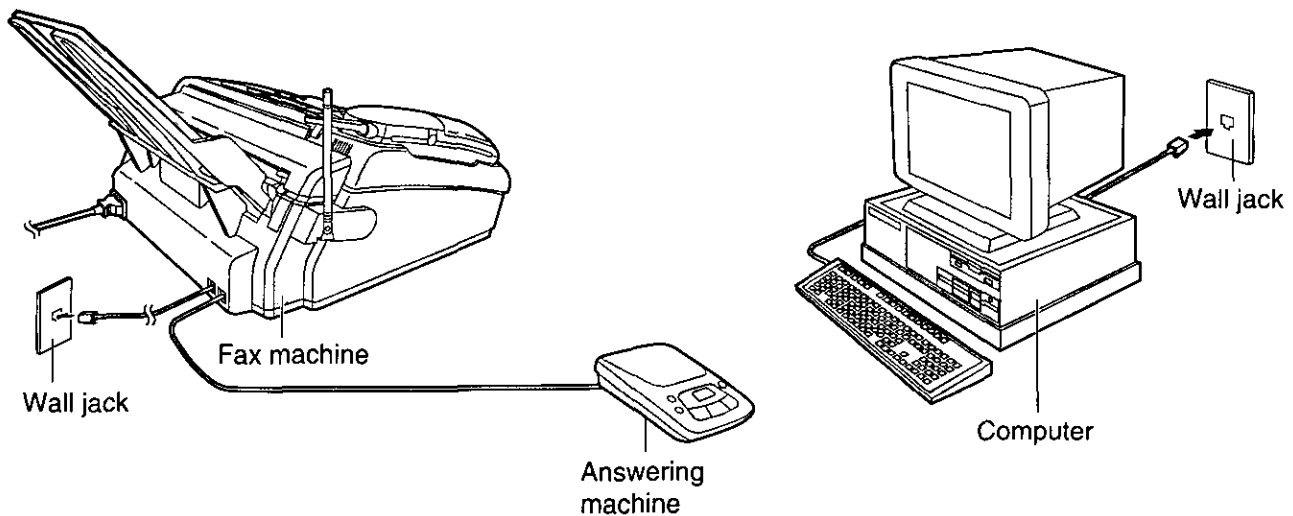

Note:

- Set the TEL mode on the fax machine.
- The device which has the shortest ring count will answer a call first. Confirm the ring count for each device.
- If you use your computer as an answering machine, connect the telephone line cord from the EXT jack on the back of the fax machine to the computer.

Remote operation of your answering machine (remote activation ID)

Some answering machines will allow you to retrieve voice messages from a remote location. To deactivate the fax machine while you are checking your messages, set the remote activation ID code for the answering machine.

Important:

- This ID must be different from the fax activation code (p. 82) and the auto disconnection code (p. 85).

- 1 Press **MENU**.
Display: 1.SYSTEM SET UP
- 2 Press **□**, then **1 2**.
REMOTE TAM ACT.
- 3 Press **START/SET/COPY**.
MODE=OFF ▼▲
- 4 Press ▼ or ▲ to select "ON".
MODE=ON ▼▲
- 5 Press **START/SET/COPY**.
ID=11

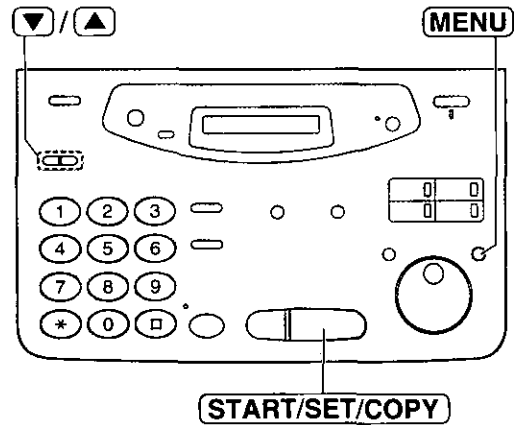

- The display will show the pre-selected ID.

- 6 Enter your ID number.
 - This ID can be from 1 to 5 digits in length using 0 - 9, * and #.
- 7 Press **START/SET/COPY**.
SETUP ITEM []
- 8 Press **MENU**.

Receiving a voice message and fax document in one call

The caller can leave a voice message and send a fax document during the same call. Inform the caller of the following procedures beforehand.

1. The caller calls your fax machine.
 - The answering machine will answer the call.
2. The caller can leave their message after the greeting message.
3. The caller presses *** 9** (pre-selected fax activation code).
 - The fax machine will activate the fax function.
4. The caller presses their start button to send a document.

Note:

- The fax activation code can be changed (p. 82).
- If the wrong fax activation code is entered, the caller must wait at least 5 seconds to reenter the correct code.

Receiving Faxes

Distinctive Ring service --- --- (ring pattern detection feature)



This feature can only be used if you subscribe to a Distinctive Ring service from your telephone company. For more information on the availability of this service, contact your telephone company.

This feature will work regardless of the AUTO ANSWER or receive mode settings.

What is a Distinctive Ring service?

A Distinctive Ring service will give you up to 3 telephone numbers on a single telephone line, each having a different ring pattern.

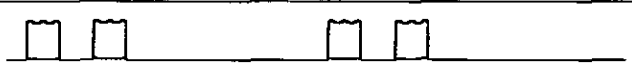
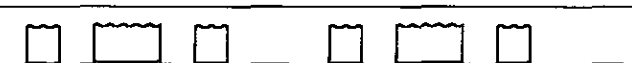
Ring patterns:

Standard ring (one long ring)	
Double ring (two short rings)	
Triple ring (short-long-short rings)	
Other triple ring (short-short-long rings)	

If you subscribe to a Distinctive Ring service, you can assign telephone numbers for personal numbers, business numbers, fax numbers, and so on.

When a call is received, you will know which number is being called by the ring pattern.

Example:

Your telephone number	Ring pattern	Use
012 1234	Standard ring	Personal
012 5678	Double ring	Business
012 9876	Triple ring	Facsimile

Using one of the telephone numbers as a facsimile number

Program the ring pattern assigned to the facsimile number (see next page).

When the unit detects a call matching the selected Distinctive Ring pattern, it will activate the fax function.

Setting the Distinctive Ring pattern assigned for faxes

Select the ring pattern of the facsimile number that is assigned by your telephone company.

1 Press **MENU**.
Display: 1.SYSTEM SET UP

2 Press **□**, then **3 1**.
RING DETECTION

3 Press **START/SET/COPY**.
MODE=OFF ▼▲

4 Press ▼ or ▲ to select the ring pattern to be assigned to the facsimile number.
A: Standard ring (one long ring)
B: Double ring (two short rings)
C: Triple ring (short-long-short rings)
D: Other triple ring (short-short-long rings)
OFF: Turns off the feature (pre-selected setting).

5 Press **START/SET/COPY**.
• When the setting is changed from OFF to either A, B, C or D, the unit will print an information list.

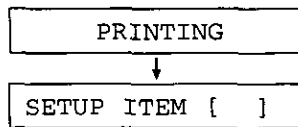

6 Press **MENU**.

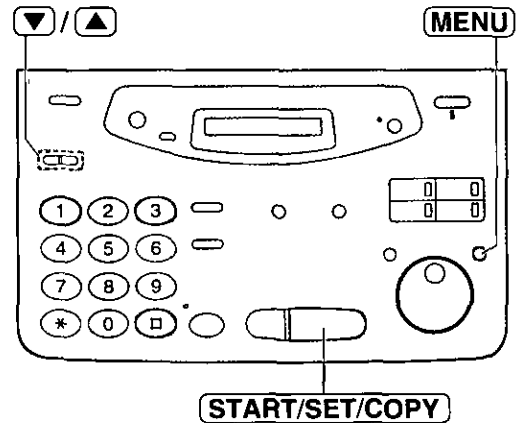

Note:

- The unit will automatically answer a Distinctive Ring call after the second ring regardless of the AUTO ANSWER, receive mode or ring count setting.
- If you have only 1 Distinctive Ring number, the most likely setting will be "B".

Receiving Faxes

TEL/FAX mode --- --- (receiving voice calls with rings and fax calls without rings when you are near the unit)

Use this mode when you are always near the unit, are not using an answering machine, and want the fax machine to detect faxes without ringing. When a call is received, the unit will work as follows. If you have an extension telephone connected, see next page.

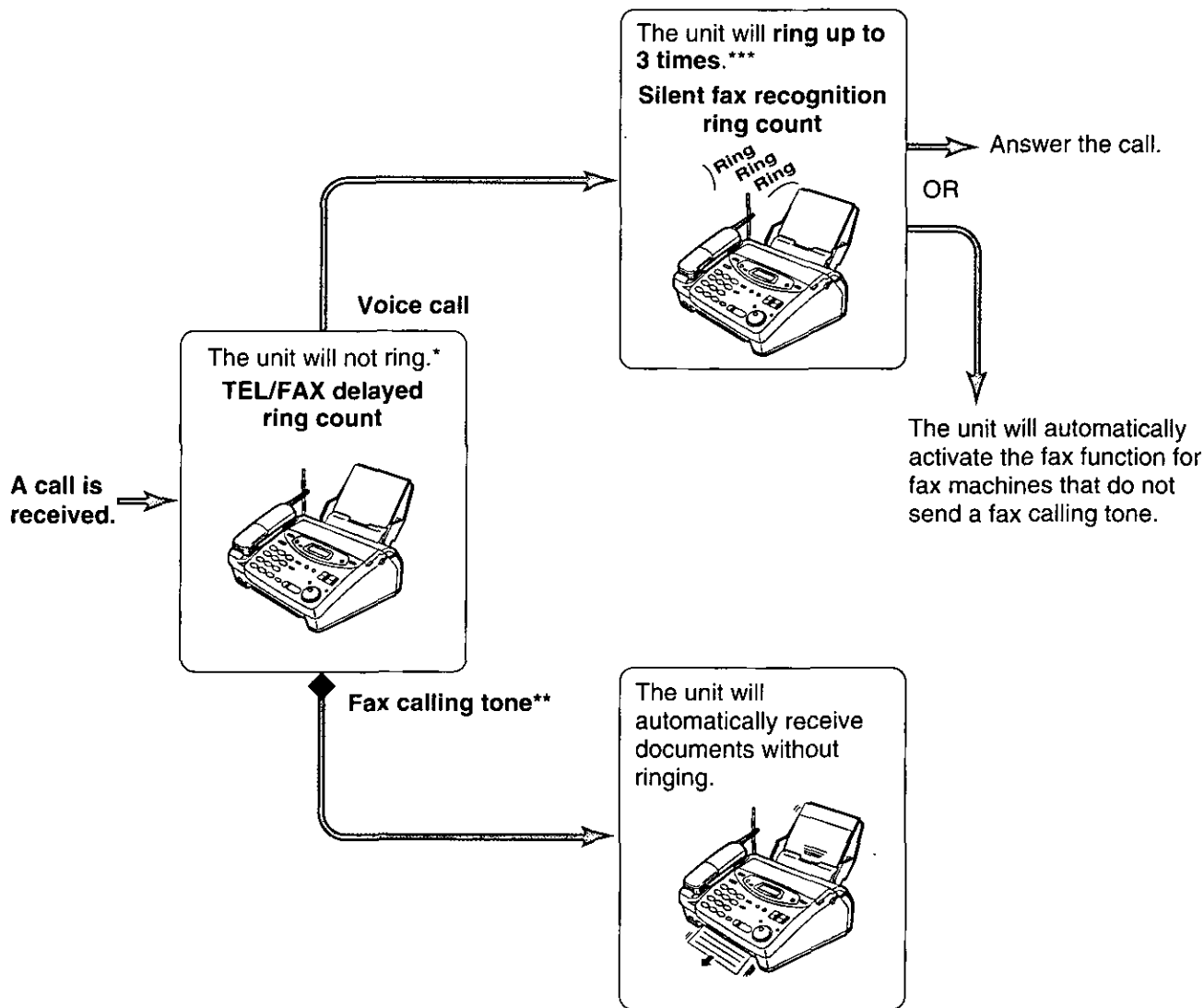

* A telephone fee will be charged to the caller from this point.

** A fax calling tone is automatically generated by the sending fax machine. Some fax machines do not have this capability.

*** While ringing, the unit will emit a different ring back tone to the calling party.

Note:

- The unit will display the following when a call is received.

Display: INCOMING CALL

- The ringer should be on (p. 32).

Ring pattern when an extension telephone is connected

If you absolutely must use another phone on the same phone line, you can disengage the TEL/FAX mode on a call by call basic by pressing *0 before the fax machine begins communicating.

Once the fax machine has activated, the only way to turn it off is by pressing the **STOP** button on the unit.

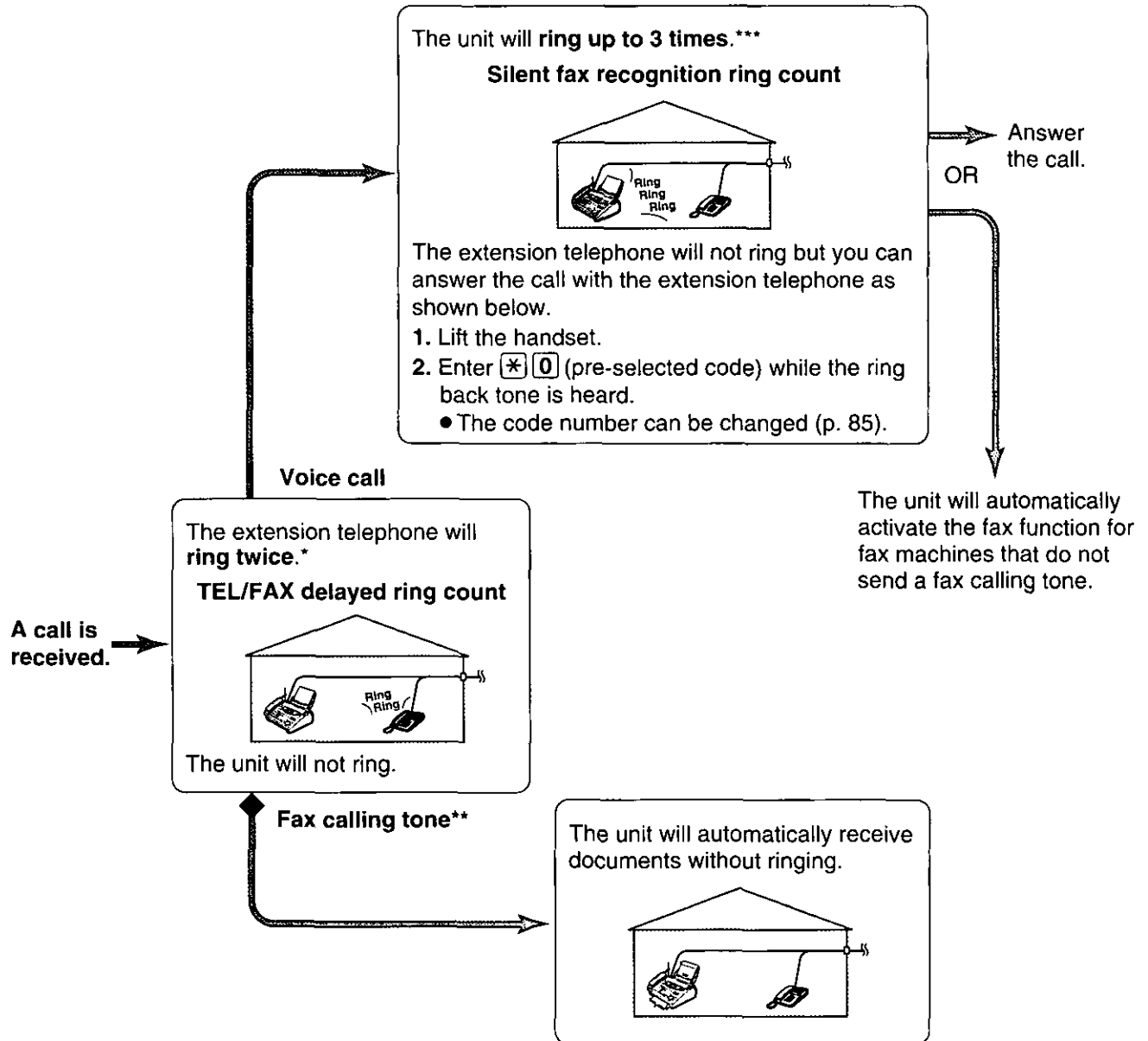

TEL/FAX delayed ring count:

Up to 4 ring signals will be generated before the unit answers, depending on feature setting #78 on page 81. In the TEL/FAX mode, the unit will not generate an audible ring during this time.

Silent fax recognition ring count:

The unit generates audible rings to indicate that it is receiving a voice call. 3 to 6 rings will be generated, depending on feature setting #30 on page 81. This signal will not ring at an extension telephone.

Receiving Faxes

Changing the AUTO ANSWER setting to the TEL/FAX mode

1 Press **MENU**.
Display: 1.SYSTEM SET UP

2 Press **⏏**, then **7 7**.
AUTO ANSWER

3 Press **START/SET/COPY**.
MODE=FAX ONLY ▼▲

4 Press ▼ or ▲ to select "TEL/FAX".
MODE=TEL/FAX ▼▲

5 Press **START/SET/COPY**.
PRINTING

• The unit will print an information list.

SETUP ITEM []

6 Press **MENU**.

7 If the AUTO ANSWER light is off, turn it on by pressing **AUTO ANSWER**.

TEL/FAX MODE

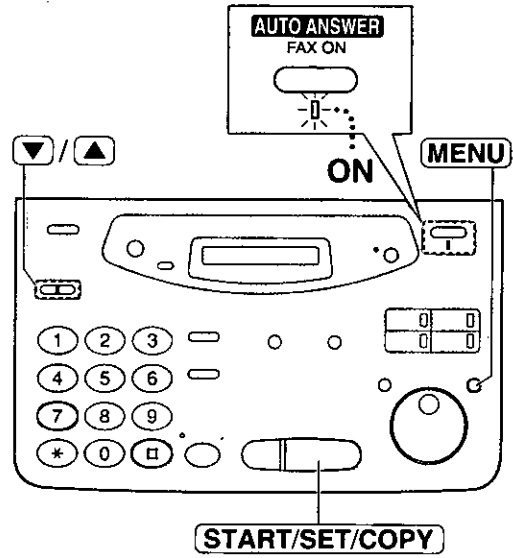

Note:

- To return to the FAX ONLY mode, select "FAX ONLY" in step 4.

We recommend the following setup.

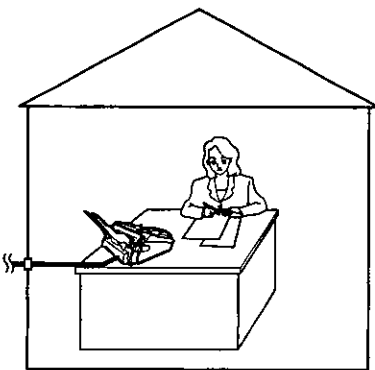

You are always near the fax machine.

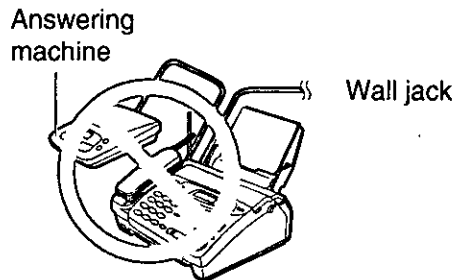

- Do not connect an answering machine when using the TEL/FAX mode.

TEL/FAX delayed ring count

This setting determines the number of times the extension telephone rings in the TEL/FAX mode. You can choose from 1 to 4 rings.

This setting does not need to be changed if an extension telephone is not connected.

- 1 Press **MENU**.
Display: 1.SYSTEM SET UP
- 2 Press **□**, then **7 8**.
TEL/FAX RING
- 3 Press **START/SET/COPY**.
RING=2 ▼▲
- 4 Press ▼ or ▲ to select the desired number, or enter the number using the dial keypad.
- 5 Press **START/SET/COPY**.
SETUP ITEM []
- 6 Press **MENU**.

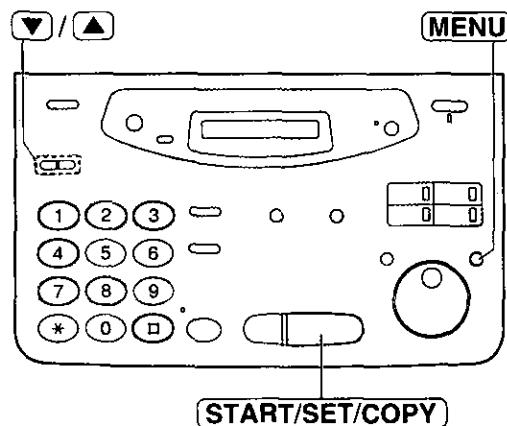

Note:

- If the number of rings is increased, you may not be able to receive documents from some older model fax machines which do not send a fax calling tone.
- If you subscribe to a Caller ID service, set this ring count setting to 2 or more rings.

Fax/Copy

Silent fax recognition ring count

When the unit detects a voice call in the TEL/FAX mode, it will ring up to 3 times. The number of rings can be changed up to 6.

- 1 Press **MENU**.
Display: 1.SYSTEM SET UP
- 2 Press **□**, then **3 0**.
SILENT FAX RING
- 3 Press **START/SET/COPY**.
RING=3 ▼▲
- 4 Press ▼ or ▲ to select the desired number, or enter the number using the dial keypad.
- 5 Press **START/SET/COPY**.
SETUP ITEM []
- 6 Press **MENU**.

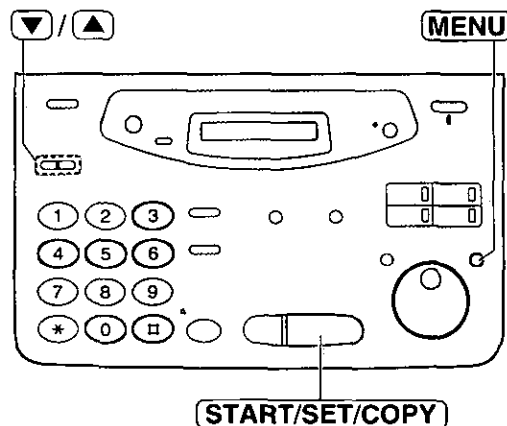

Note:

- If the number of rings is increased, you may not be able to receive documents from some older model fax machines which do not send a fax calling tone.

Receiving Faxes

Extension telephone

If you connect an extension telephone to your unit or to the same line, you can receive fax documents using the extension telephone.

You do not have to press **START/SET/COPY** on the unit.

Important:

- Use a touch tone telephone as the extension telephone and enter the fax activation code **firmly**.

- 1 When the extension telephone rings, lift the handset of the extension telephone.
- 2 When:
 - document reception is required,
 - a fax calling tone (slow beep) is heard, or
 - no sound is heard,press *** 9** (pre-selected fax activation code) **firmly**.
- 3 Hang up the handset.
 - The unit will start reception.

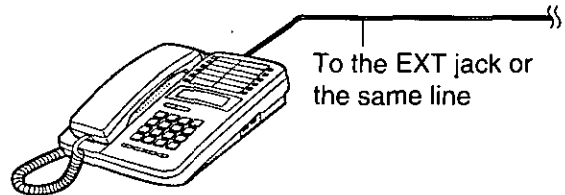

Extension telephone

Note:

- You can change the fax activation code (see below).

Fax activation code

The fax activation code is required in the following cases;

- to receive faxes using an extension telephone (see above).
- to receive a voice message and fax document in the same call (p. 75).

Important:

- This code should be different from the remote activation ID (p. 75) and the auto disconnection code (p. 85).

- 1 Press **MENU**.
Display: 1.SYSTEM SET UP
- 2 Press **□**, then **4 1**.
FAX ACTIVATION
- 3 Press **START/SET/COPY**.
MODE=ON ▼▲
- 4 Press ▼ or ▲ to select "ON".
 - If this feature is not required, select "OFF".
- 5 Press **START/SET/COPY**.
CODE= * 9

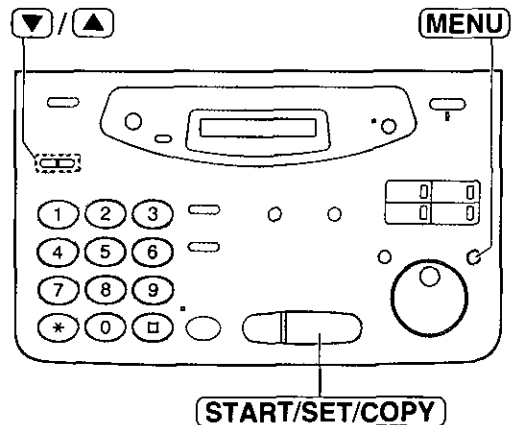

- The display will show the pre-selected code.
- 6 Enter the new code.
 - This code can be from 2 to 4 digits in length using 0 – 9, and *.
 - 7 Press **START/SET/COPY**.
SETUP ITEM []
 - 8 Press **MENU**.

Note:

- If you subscribe to any special telephone company services which require a code, all or part of the fax activation code must be different from the service access code.
- The fax activation code should not be set to "0000".

Other size documents

When the size of the document sent by the other party is as large as, or larger than the recording paper, the unit can reduce each page of the document and print it out on the recording paper by programming a suitable reduction rate.

The reduction rate is determined by a combination of the size of the recording paper and the received document.

Recommended reduction rates:

Mode	Size of recording paper	Size of original document
100%	Legal	Letter, A4
92% (pre-selected)	Letter	Letter
	Legal	Legal
86%	Letter	A4
72%	Letter	Legal

Letter = 216 mm x 279 mm (8½" x 11")

Legal = 216 mm x 356 mm (8½" x 14")

A4 = 210 mm x 297 mm (May not be available in the United States.)

- 1 Press **MENU**.
Display: 1.SYSTEM SET UP
- 2 Press **3**, then **6**.
RCV REDUCTION
- 3 Press **START/SET/COPY**.
MODE=92% ▼▲
- 4 Press ▼ or ▲ to select the desired setting.
● If this feature is not required, press ▲ to select "100%".
- 5 Press **START/SET/COPY**.
SETUP ITEM []
- 6 Press **MENU**.

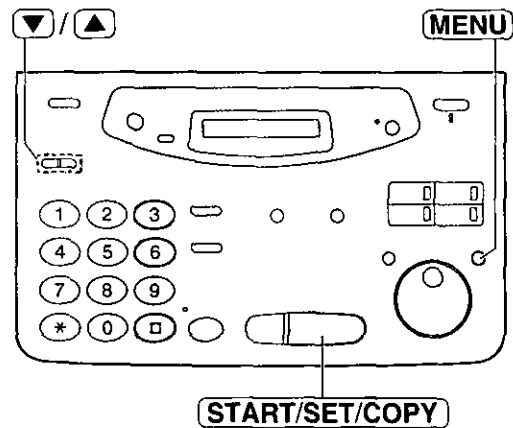

Note:

- Documents usually have a heading on the top of each page which contains the sender's name/telephone number. This increases the length of each page. Using the reduction mode is recommended.
- If the appropriate reduction rate is not programmed, the document will be divided.

Receiving Faxes

Silent detection --- --- (receiving faxes from older model fax machines)

This feature allows the unit to activate the fax function automatically if a silent pause longer than 4 seconds is detected when using an answering machine.

Helpful hints:

- If you wish to receive document from fax machines that do not send a fax calling tone, activate this feature.
- If you use an answering machine to give greeting messages and record incoming messages on a single cassette tape, deactivate this feature.

- 1 Press **MENU**.
Display: 1.SYSTEM SET UP
- 2 Press **□**, then **4 0**.
SILENT DETECT.
- 3 Press **START/SET/COPY**.
MODE=ON ▼▲
- 4 Press ▼ or ▲ to select the desired setting.
• If this feature is not required, select "OFF".
- 5 Press **START/SET/COPY**.
SETUP ITEM []
- 6 Press **MENU**.

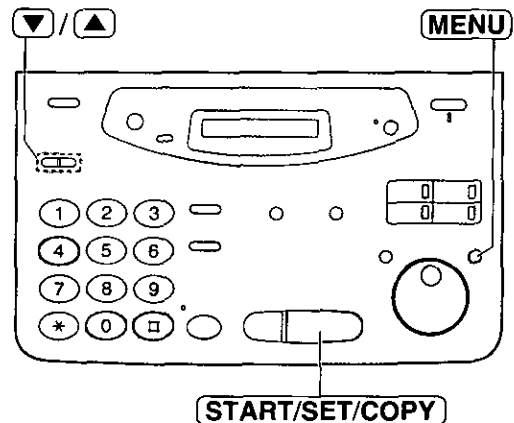

Memory reception alert --- ---

When the received document is stored into memory due to a problem, the unit will alert you with beep tones. If you hear slow beeps, clear the printing problem or supply paper to print the stored document. The beep tones will stop.

- 1 Press **MENU**.
Display: 1.SYSTEM SET UP
- 2 Press **□**, then **4 4**.
RECEIVE ALERT
- 3 Press **START/SET/COPY**.
MODE=ON ▼▲
- 4 Press ▼ or ▲ to select the desired setting.
• If this feature is not required, select "OFF".
- 5 Press **START/SET/COPY**.
SETUP ITEM []
- 6 Press **MENU**.

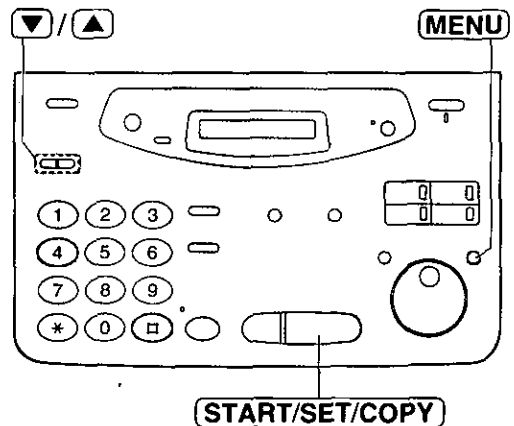

Friendly reception

The friendly reception feature allows you to receive fax document automatically without pressing **START/SET/COPY** (p. 70).

When this feature is deactivated, you have to press **START/SET/COPY** to receive a fax document each time you answer a fax call.

- 1 Press **MENU**.
Display: 1. SYSTEM SET UP
- 2 Press **□**, then **4 6**.
FRIENDLY RCV
- 3 Press **START/SET/COPY**.
MODE=ON ▼▲
- 4 Press ▼ or ▲ to select the desired setting.
• If this feature is not required, select "OFF".
- 5 Press **START/SET/COPY**.
SETUP ITEM []
- 6 Press **MENU**.

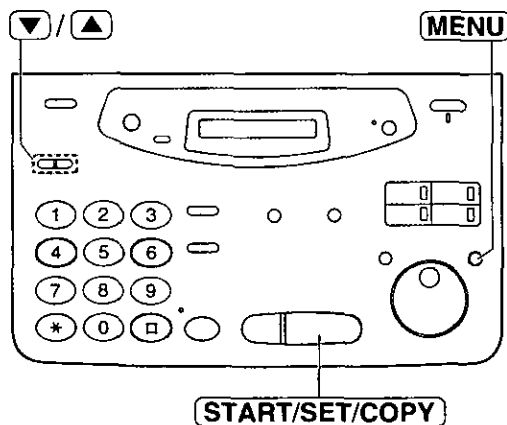

Fax/Copy

Auto disconnection

This feature allows you to answer a call with the extension telephone during the silent fax recognition rings in the TEL/FAX mode (p. 79). When you lift the handset of the extension telephone and enter *** 0** (pre-selected code) while the ring back tone is heard, the unit will be disconnected and you can talk with the other party.

Important:

- This code should be different from the remote activation ID (p. 75) and the fax activation code (p. 82).

- 1 Press **MENU**.
Display: 1. SYSTEM SET UP
- 2 Press **□**, then **4 9**.
AUTO DISCONNECT
- 3 Press **START/SET/COPY**.
MODE=ON ▼▲
- 4 Press ▼ or ▲ to select "ON".
• If this feature is not required, select "OFF".
- 5 Press **START/SET/COPY**.
CODE= * 0
- 6 Enter the new code.
• The display will show the pre-selected code.
• This code can be from 2 to 4 digits in length using 0 - 9, and *.
- 7 Press **START/SET/COPY**.
SETUP ITEM []
- 8 Press **MENU**.

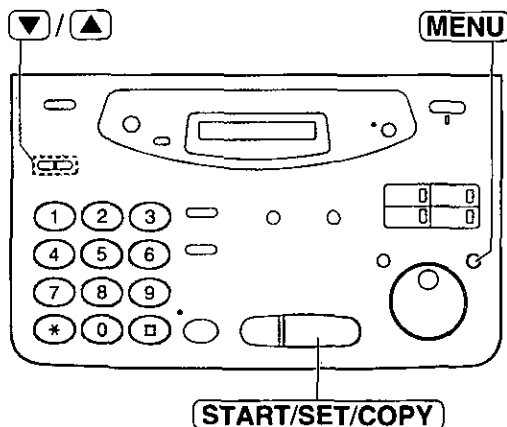

Receiving Faxes

Pager call - when your unit receives a fax

This feature allows your unit to call your pager when your unit receives a fax document.

- 1 Press **MENU**.
Display: 1.SYSTEM SET UP
- 2 Press **□**, then **7 0**.
FAX PAGER CALL
- 3 Press **START/SET/COPY**.
MODE=OFF ▼▲
- 4 Press ▼ or ▲ to select "ON".
MODE=ON ▼▲
- 5 Press **START/SET/COPY**.
NO. =
- 6 Enter your pager number.
• You can enter a total of 46 digits and/or pauses.
Example:
1 202 555 1234PPP12345678PPP5555#
Your pager number
Pauses
Your pager access code, if required.
Message you want displayed on your pager when your unit receives a fax.
- 7 Press **START/SET/COPY**.
• The unit will dial the stored pager number.
PAGER TEST
- 8 Confirm that your pager receives a pager test call.
- 9 Press **MONITOR**.
- 10 If the AUTO ANSWER light is off, turn it on by pressing **AUTO ANSWER**.

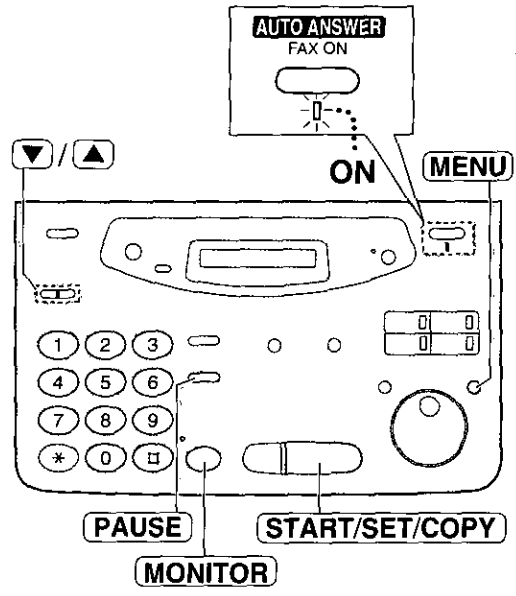

How your unit and pager work

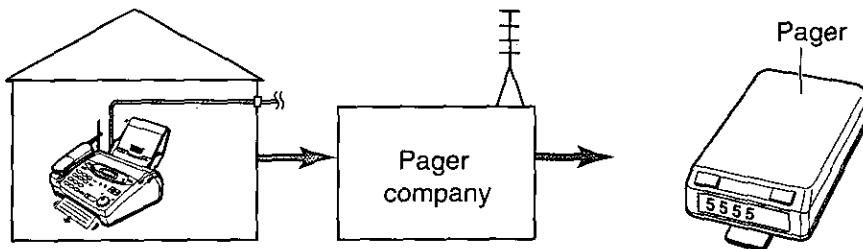

When your unit receives a fax document, it will call your pager company.

Your pager company will call your pager.

A few minutes later, your pager will display the same message you entered in step 6 above. (For example: 5555)
If you have subscribed to a Caller ID service and the Caller ID information (telephone number) is received, your pager will display the telephone number.

Film detection

If this feature is activated, the display will show the following message when the remaining film will only print about 15 letter size document.

Display: FILM NEAR EMPTY

- If you are using regular film cartridge with 100 m (328') roll (p. 16) when the above message is displayed, the unit will also print a report.

- 1 Press **MENU**.
Display: 1.SYSTEM SET UP
- 2 Press **□**, then **7 9**.
FILM DETECTION
- 3 Press **START/SET/COPY**.
MODE=ON ▼▲
- 4 Press ▼ or ▲ to select the desired setting.
• If this feature is not required, select "OFF".
- 5 Press **START/SET/COPY**.
SETUP ITEM []
- 6 Press **MENU**.

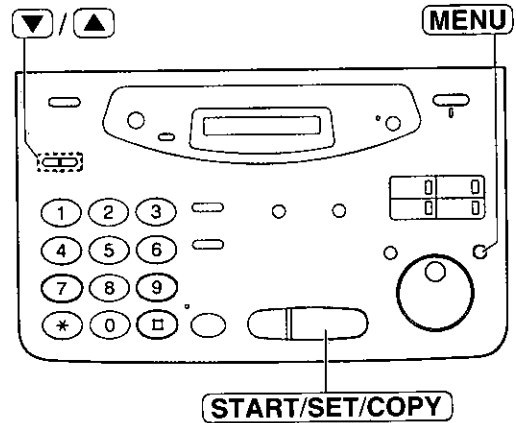

Fax/Copy

Copying

Making a copy

The unit can make single or multiple copies (up to 99). Any transmittable document (p. 59) can be copied.

- 1 Open the document feeder tray.
- 2 Adjust the width of the document guides to the size of the document.
- 3 Insert the document (up to 15 pages) FACE DOWN until a single beep is heard and the unit grabs the document.

Display:

- 4 If necessary, press **RESOLUTION** repeatedly to select the desired setting (p. 53).

- 5 Press **START/SET/COPY**.

- 6 Enter the number of copies (up to 99).

- 7 If necessary, choose an enlargement/reduction rate by rotating **JOG DIAL**. See next page.

- 8 If you want to print collated copies, press **COLLATE** until the following is displayed (see below).

- 9 Press **START/SET/COPY**.

- The unit will start printing.

OR

Press **QUICK SCAN** if you want to remove the copy document for other uses.

- The unit will feed the document and scan it into memory, then start printing.

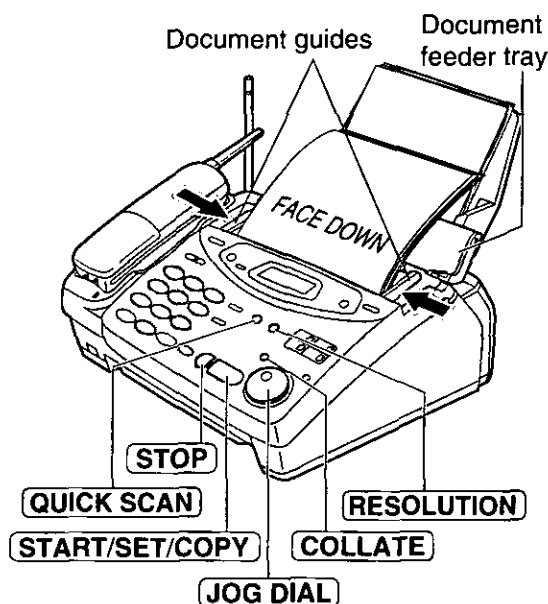

Note:

- After step 5, if you do not make any operations within 15 seconds of each other, the unit will start copying automatically.
- If a resolution is not selected, FINE resolution will be selected automatically.
- You can make or receive a voice call while making copies.
- After copying, the enlargement/reduction rate setting will return to "100%".

To stop copying

Press **STOP**.

Printing collated copies

The unit can print either uncollated or collated copies. See the example below.

Example: Making two copies of a 4 page original document

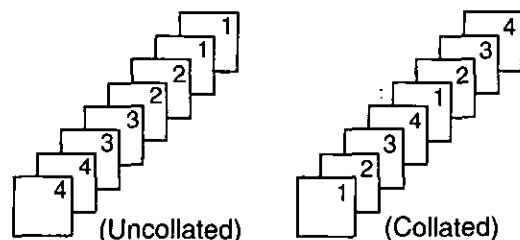

Note:

- If you turn the collating feature on, the unit will store the document into memory and print it. If memory becomes full while storing, the unit will only print out the stored pages.
- After copying, the collating feature will turn off automatically.

Choosing an enlargement/reduction rate

The unit can make enlarged or reduced copies of a document.

■ To enlarge a document:

Select "200%" or "150%" by rotating **JOG DIAL** to the right. The unit will only enlarge the center part of the document and print it on two pages. See the examples below.

Sample of an enlarged copy:

● 200% example

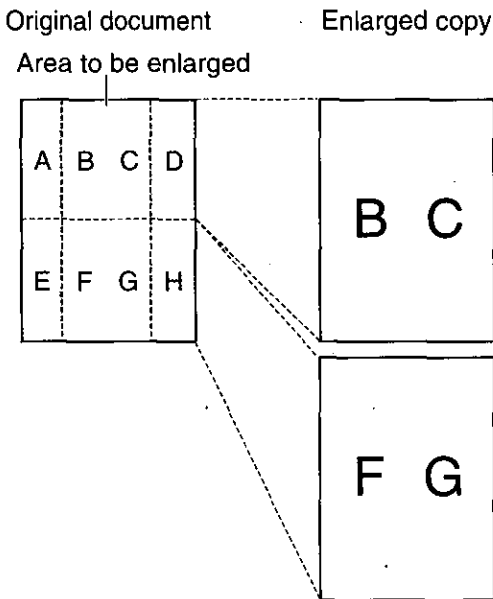

● 150% example

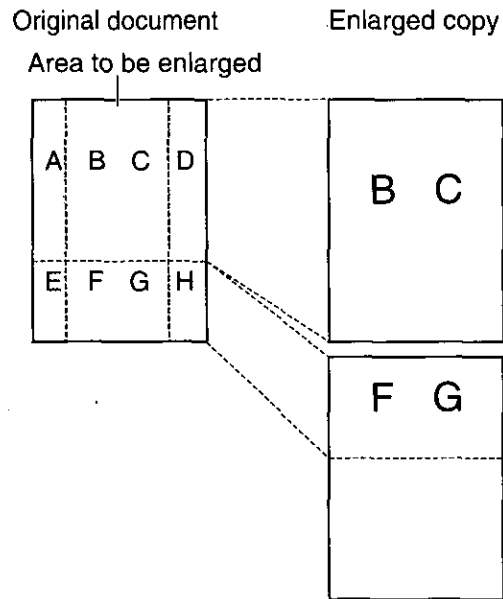

Fax/Copy

■ To reduce a document:

When you copy a document that is longer than the recording paper, the unit can reduce the original document by programming a suitable reduction rate. The reduction rate is determined by the size of the recording paper and original document. Select from 92%, 86% and 72% by rotating **JOG DIAL** to the left.

Recommended reduction rates:

Mode	Size of recording paper	Size of original document
100% (pre-selected)	Letter	Letter
	Legal	Letter, A4, Legal
92%	Letter	A4
86%	Letter	A4
72%	Letter	Legal

Letter = 216 mm x 279 mm (8½" x 11")

Legal = 216 mm x 356 mm (8½" x 14")

A4 = 210 mm x 297 mm (May not be available in the United States.)

Note:

- If the appropriate reduction rate is not programmed, the document may be divided and the top of the second sheet will be deleted.

Error Messages

Reports

If your unit cannot send a fax, check the following.

- The number you dialed is correct.
- The other party's machine is a facsimile.

If the problem remains, correct it by following the communication message printed on the sending and journal reports (p. 60, 61).

Communication message	Error code	Cause & Remedy
COMMUNICATION ERROR	41–72 FF	● A transmission or reception error occurred. Try again or check with the other party.
DOCUMENT JAMMED	—	● The document is jammed. Remove the jammed document (p. 101).
ERROR-NOT YOUR UNIT	54, 59 70	● A transmission or reception error occurred because of a problem with the other party's fax machine. Check with the other party.
MEMORY FULL	—	● The document was not received due to memory being full.
NO DOCUMENT	—	● The document was not fed into the unit properly. Reinsert the document and try again.
OTHER FAX NOT RESPOND	—	● The other party's fax machine was busy or ran out of recording paper. Try again. ● The document was not fed properly. Reinsert the document and try again. ● The other party's fax machine rings too many times. To send a fax manually, dial the number, confirm the fax tone, and press START/SET/COPY . ● The other party's machine is not a facsimile. Check with the other party. ● The number you dialed is not in service.
PRESSED THE STOP KEY	—	● STOP was pressed and fax communication was canceled.
THE COVER WAS OPENED	—	● The cover was opened. Close it and try again.
OK	—	● Fax communication was successful.

Display

If the unit detects a problem, one or more of the following messages will appear on the display.

Display message	Cause & Remedy
CALL SERVICE	<ul style="list-style-type: none"> There is something wrong with the unit. Contact our service personnel.
CHECK COVER	<ul style="list-style-type: none"> The cover is open. Close it.
CHECK DOCUMENT	<ul style="list-style-type: none"> The document is not fed into the unit properly. Reinsert the document. If misfeeding occurs frequently, clean the document feeder rollers and try again (p. 106). If the problem remains, adjust the feeder pressure (p. 102).
CHECK FILM	<ul style="list-style-type: none"> The film cartridge is not installed. Install it (p. 104, 105).
CHECK MEMORY	<ul style="list-style-type: none"> Memory (telephone numbers, parameters, etc.) has been erased. Re-program.
CHECK PAPER	<ul style="list-style-type: none"> The recording paper is not installed or the unit has run out of paper. Install paper and press START/SET/COPY to clear the message. The recording paper is not fed into the unit properly or has jammed near the recording paper entrance. Clear the jammed paper and press START/SET/COPY to clear the message (see "When paper has jammed near the recording paper entrance" on page 100). Do not install folded or heavily curled paper in the paper tray.
FAX IN MEMORY	<ul style="list-style-type: none"> The unit has a document in memory. See the other displayed message instructions to print out the document.
FAX MEMORY FULL	<ul style="list-style-type: none"> Memory is full of received documents due to a lack of recording paper or a recording paper jam etc. Install paper or clear the jammed paper. When performing memory transmission, the document being stored exceeds the memory capacity of the unit. Transmit the entire document using manual or automatic transmission.
FILM EMPTY	<ul style="list-style-type: none"> The film is empty. Replace the film cartridge (p. 104, 105). The film is slack. Tighten it (see step 4 on page 105) and install again.
FILM NEAR EMPTY	<ul style="list-style-type: none"> The remaining film can print about 15 pages of letter size document. Prepare a new film cartridge (p. 16).
FREE FILM EMPTY	<ul style="list-style-type: none"> The free starter film is empty. Replace the film cartridge (p. 104, 105).
JOG-DIAL FULL	<ul style="list-style-type: none"> There is no space to store new stations in the JOG DIAL directory. Edit or erase unnecessary stations (p. 44).
LOADING ERROR	<ul style="list-style-type: none"> A loading error occurred while receiving data from FaxSav. Contact FaxSav at 1-888-332-9728.
MEMORY FULL	<ul style="list-style-type: none"> When making a copy, the document being stored exceeds the memory capacity of the unit. Press STOP to clear the message.
MODEM ERROR	<ul style="list-style-type: none"> There is something wrong with the modem circuit. Contact our service personnel.

(continued)

Error Messages

Display message	Cause & Remedy
NO FAX REPLY	● The other party's fax machine is busy or has run out of recording paper. Try again.
PAPER JAMMED	● A recording paper jam occurred under the film cartridge. Clear the jammed paper (p. 99).
PLEASE WAIT	● The unit is checking that there is no slack on the film. Wait a while.
REDIAL TIME OUT	● The other party's fax machine is busy or has run out of recording paper. Try again.
REMOVE DOCUMENT	● The document is jammed. Remove the jammed document (p. 101). ● Attempted to transmit a document longer than 600 mm (23 ⁵ / ₈ "). Press STOP to remove the document. Divide the document into two or more sheets and try again.
TRANSMIT ERROR	● A transmission error occurred. Try again.
UNIT OVERHEATED	● The unit is too hot. Let the unit cool down.

When a function does not work, check here before requesting help

General

Problem	Cause & Remedy
I cannot make and receive calls.	<ul style="list-style-type: none"> ● The power cord or telephone line cord is not connected. Check the connections (p. 24).
I cannot make calls.	<ul style="list-style-type: none"> ● The dialing mode setting is wrong. Change to "TONE" or "PULSE" (p. 38).
The main unit does not work.	<ul style="list-style-type: none"> ● Disconnect the unit from the telephone line and connect the line to a known working telephone. If the working telephone operates properly, contact our service personnel to have the unit repaired. If the working telephone does not operate properly, contact your telephone company.
The main unit does not ring.	<ul style="list-style-type: none"> ● The ringer volume is set to off. Adjust it to a suitable level (p. 32).
The main unit displays "CHECK PAPER" though the paper is inserted.	<ul style="list-style-type: none"> ● The paper is inserted halfway. Insert it correctly (p. 22, 23) and press (START/SET/COPY) to clear the message.
The other party complains they only hear a fax tone and cannot talk.	<ul style="list-style-type: none"> ● The FAX ONLY mode is set. Tell them the number is only used for faxes or change to another mode on your unit (p. 68, 69).
The receive mode does not function as explained on pages 68 and 69.	<ul style="list-style-type: none"> ● A Distinctive Ring pattern is set (p. 76, 77). ● The TEL/FAX mode is set (p. 78-81).
During programming, I cannot enter a code or ID number.	<ul style="list-style-type: none"> ● All or part of the numbers are the same. Change the number (p. 75, 82, 85).
The film runs out quickly.	<ul style="list-style-type: none"> ● The HELP button, copy function, and reports use more film.
The (HANDSET LOCATOR) button does not function.	<ul style="list-style-type: none"> ● The handset is too far from the main unit or is engaged in an outside call.
The CHARGE light never goes out while charging.	<ul style="list-style-type: none"> ● This is normal.

Operations

Cordless handset

Problem	Cause & Remedy
The handset does not work.	<ul style="list-style-type: none">● Make sure that the battery is installed correctly (p. 103).● Charge the battery fully (p. 30).● Clean the charge contacts (p. 108) and charge again.
The handset does not ring.	<ul style="list-style-type: none">● The ringer volume is set to off. Press LOUD/RINGER (p. 32).
An alarm tone sounds when I press TALK or REMOTE SP .	<ul style="list-style-type: none">● The handset is too far from the main unit. Move closer and try again.● Place the handset on the main unit and try again.● The power cord is disconnected. Plug in the power cord.
An alarm tone sounds continuously while using the handset.	<ul style="list-style-type: none">● Quickly, move closer to the main unit or the call will be terminated within 60 seconds.● The power cord is disconnected. Plug in the power cord.
Static, sound cuts in/out, fades. Interference from other electrical units.	<ul style="list-style-type: none">● Locate the handset and the main unit away from electrical appliances.● Move closer to the main unit.● Press CH to select a clear channel.● Raise the main unit antenna.
The handset stops working while being used.	<ul style="list-style-type: none">● Place the handset on the main unit, and disconnect the power cord to reset the unit. Connect the power cord, and try again.
I cannot store a telephone number in the handset memory.	<ul style="list-style-type: none">● You cannot store a number while the unit is in the talk or intercom mode.● Do not pause for over 30 seconds while storing.
While storing a telephone number in the handset, it starts to ring.	<ul style="list-style-type: none">● To answer a call, press TALK. The program will be canceled. Store the number again.
I cannot redial by pressing REDIAL/PAUSE .	<ul style="list-style-type: none">● The redial function does not work right after storing telephone numbers in the handset or DIRECT (p. 39, 40).● If the last number dialed was more than 32 digits long, the number will not be redialed.
The RECHARGE indicator flashes or the handset beeps intermittently.	<ul style="list-style-type: none">● Charge the battery fully (p. 30).
I charged the battery fully, but the RECHARGE indicator flashes.	<ul style="list-style-type: none">● Clean the charge contacts (p. 108) and charge again.● It is time to replace the battery. Please purchase a new battery (p. 16).
I cannot receive documents by pressing FAX on the handset.	<ul style="list-style-type: none">● Press FAX until a single beep is heard.

Fax – sending

Problem	Cause & Remedy
I cannot send a document.	<ul style="list-style-type: none"> ● The telephone line cord is connected to the EXT jack on the unit. Connect to the LINE jack (p. 24). ● The other party's fax machine is busy or has run out of paper. Try again. ● The other party's machine is not a facsimile. Check with the other party. ● The other party's fax machine rings too many times. Send the fax manually – dial the number, confirm the fax tone, then press (START/SET/COPY).
The other party complains that letters on their received document are distorted.	<ul style="list-style-type: none"> ● If your line has special telephone services such as call waiting, the service may have been activated during fax transmission. Connect the unit to a line that does not have these services. ● The extension telephone on the same line is off the hook. Hang up the extension telephone and try again.
The other party complains that dirty patterns or black lines appear on their received document.	<ul style="list-style-type: none"> ● The glass or rollers are dirty. Clean them (p. 106).
I cannot make an international fax call.	<ul style="list-style-type: none"> ● Use the overseas transmission mode (p. 67). ● Add two pauses at the end of the telephone number (p. 37) or dial manually.

Fax – receiving



Problem	Cause & Remedy
I cannot receive documents.	<ul style="list-style-type: none"> ● The telephone line cord is connected to the EXT jack on the unit. Connect to the LINE jack (p. 24).
I cannot receive documents automatically.	<ul style="list-style-type: none"> ● The receive mode is set to the TEL mode. Set to the FAX ONLY or TEL/FAX mode. ● The time taken to answer a call is too long. Decrease the number of rings (p. 72, 81).
The display shows "CONNECTING....." but faxes are not received.	<ul style="list-style-type: none"> ● The incoming call is not a fax. Change the receive mode to the TEL mode.
The recording image is faint.	<ul style="list-style-type: none"> ● The sender transmitted a faint document. Ask them to transmit a clearer copy of the document. ● The thermal head is dirty. Clean it (p. 107).
The printing quality is poor.	<ul style="list-style-type: none"> ● Some paper has instructions recommending which side to print on. Try turning the paper over. We recommend smooth paper such as Hammermill® Jet Print for clearer printing.
A blank sheet is ejected after the received document is printed out.	<ul style="list-style-type: none"> ● The receiving reduction rate is not programmed correctly. Program the proper rate (p. 83).
I cannot receive documents by pressing (FAX) on the handset.	<ul style="list-style-type: none"> ● Press (FAX) until a single beep is heard.

Operations

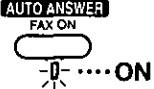
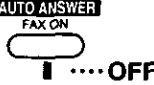
Receive mode

Problem	Cause & Remedy
<p>I cannot select the desired receive mode.</p>	<ul style="list-style-type: none"> ● If you want to set the FAX ONLY or TEL/FAX mode: <ul style="list-style-type: none"> – Select the desired mode using feature #77 (p. 80), and – Press AUTO ANSWER to turn on the AUTO ANSWER light. <div style="text-align: center;">  </div> <ul style="list-style-type: none"> ● If you want to set the TEL mode: <ul style="list-style-type: none"> – Press AUTO ANSWER to turn off the AUTO ANSWER light. <div style="text-align: center;">  </div>

Copying

Problem	Cause & Remedy
<p>The unit does not make a copy.</p>	<ul style="list-style-type: none"> ● You cannot make a copy during programming. Make the copy after programming or stop the programming.
<p>A dirty pattern or a black line appears on the copied document.</p>	<ul style="list-style-type: none"> ● The glass or rollers are dirty. Clean them (p. 106).
<p>The copied image is distorted.</p>	<ul style="list-style-type: none"> ● The thermal head is dirty. Clean it (p. 107).
<p>The printing quality is poor.</p>	<ul style="list-style-type: none"> ● Some paper has instructions recommending which side to print on. Try turning the paper over. We recommend smooth paper such as Hammermill® Jet Print for clearer printing.
<p>The printing is faint.</p> <div style="display: flex; justify-content: space-around; align-items: center; margin-top: 10px;"> <div style="text-align: center;"> <p>Original</p>  </div> <div style="text-align: center;"> <p>Copy</p>  </div> </div>	<ul style="list-style-type: none"> ● You may have used paper with a cotton and/or fiber content that is over 20%, such as letterhead or resume paper. We recommend smooth paper such as Hammermill® Jet Print for clearer printing.

Using an answering machine

Problem	Cause & Remedy
<p>I cannot receive documents automatically.</p>	<ul style="list-style-type: none"> ● Your greeting message on the answering machine is too long. Shorten the message (up to 10 seconds). ● The answering machine rings too many times. Set to 1 or 2 rings. ● The silent detection feature is deactivated. Activate this feature (p. 84).
<p>I cannot receive voice messages.</p>	<ul style="list-style-type: none"> ● Check if the answering machine is turned on and connected to the unit properly (p. 73). ● Set the number of rings on the answering machine to 1 or 2.
<p>I cannot retrieve recorded voice messages on the answering machine from a remote location.</p>	<ul style="list-style-type: none"> ● The remote access code on your answering machine is the same as your fax activation code. Set a different number for each code. ● You did not program your remote access code in your fax machine correctly. Program the same code that is programmed on the answering machine (p. 75).
<p>The greeting message on the answering machine is interrupted halfway and the caller cannot leave a voice message.</p>	<ul style="list-style-type: none"> ● The greeting message has a silent pause longer than 4 seconds. Re-record the greeting message.
<p>I pressed the remote access code to access the answering machine remotely, but the line was disconnected.</p>	<ul style="list-style-type: none"> ● The code may include “#” which is used for certain features provided by the telephone company. Change the code on the answering machine to another number which does not include “#” (p. 75).
<p>Callers complain that their voice message is interrupted halfway and they cannot leave a message.</p>	<ul style="list-style-type: none"> ● Advise the caller not to pause for over 4 seconds while recording their voice message.
<p>Callers complain that they cannot send a document.</p>	<ul style="list-style-type: none"> ● Your answering machine ran out of recording tape. Rewind the tape to record messages. ● You set the answering machine to only give a greeting message.
<p>When I answer a call with the extension telephone, the unit switches to the fax mode and I cannot talk with the other party.</p>	<ul style="list-style-type: none"> ● You paused for over 4 seconds during the conversation. To resume the conversation, press STOP on the unit.

Help

Operations

If a power failure occurs

- The unit will not function.
- Fax transmission and reception will be interrupted.
- If fax documents are stored in memory, they will be lost. When power is restored, a power down report will be printed out stating which contents in memory have been erased.
- If delayed transmission is programmed and the start time has passed during a power failure, transmission will be attempted soon after power is restored.
- If an extension telephone/answering machine is connected to the unit, you can use it during a power failure.

Power down report

The power down report will be automatically printed out after power is restored.
The report will not be printed out if there are no documents stored in memory.

Sample of a power down report

POWER DOWN REPORT				
			POWER DOWN AT:Jan. 05 1999 04:30AM	
			RESTARTED AT:Jan. 05 1999 04:31AM	
<< WARNING >>				
CONTENTS HAVE BEEN CLEARED DUE TO POWER DOWN.				
FOR ADDITIONAL INFORMATION, PLEASE SEE THE JOURNAL REPORT.				
NO.	OTHER FACSIMILE	MODE	PAGES	FUNCTION
01	<FAX # NOT AVAIL.>	RCV	01	MEMORY RECEIVE

Recording paper jams

If the unit does not eject any recording paper during reception or copying, the recording paper has jammed. Remove the jammed paper following the instructions on this page or page 100.

When paper has jammed under the film cartridge

The display will show the following message.

Display: PAPER JAMMED

Remove the jammed paper as follows.

1 Open the cover by pressing the cover open button.

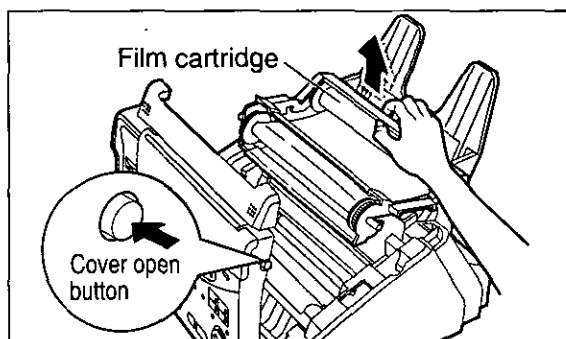

2 Remove the film cartridge.

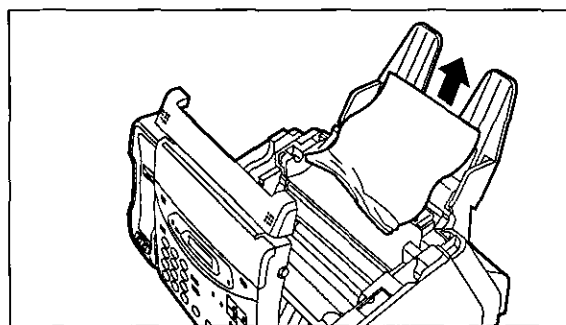

3 Remove the jammed recording paper.

4 If the film is slack, turn the film cartridge over and tighten it by winding the gears.

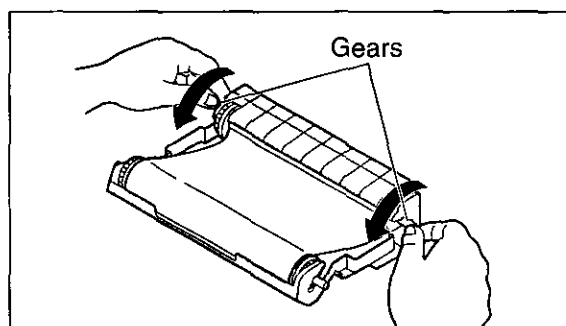
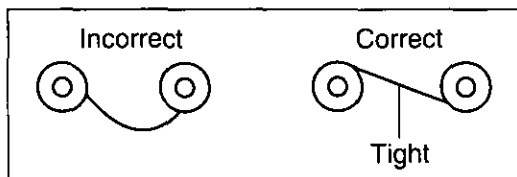

5 Turn the film cartridge over so that the "BACK" is facing up.

6 Replace the film cartridge by first placing the front of the cartridge into the unit and then lowering the "BACK" of the cartridge into place.

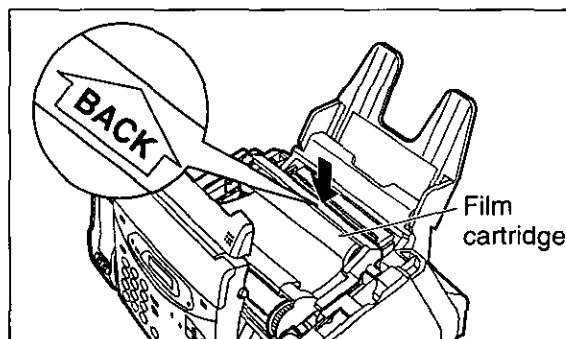

7 Close the cover securely by pushing down on the dotted area at both ends.

Help

Jams

When paper has jammed near the recording paper entrance

The display will show the following message.

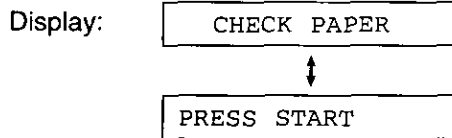

Remove the jammed paper as follows.

- 1** Pull the tension bar forward and hold open while pulling out the jammed recording paper from the recording paper entrance.
- 2** Press **START/SET/COPY** to clear the message.

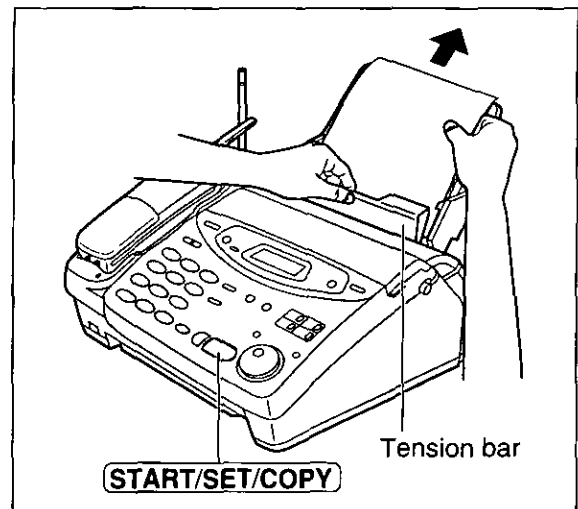

When paper has not been ejected even though “PAPER JAMMED” or “CHECK PAPER” is not displayed

Check the recording paper exit. If there is any jammed paper, remove it as follows.

- 1** Tilt the unit up and pull the jammed recording paper out of the recording paper exit.
- 2** Remove the jammed recording paper from the recording paper exit.
 - If you cannot remove the jammed paper, remove it by following the instructions on page 99.

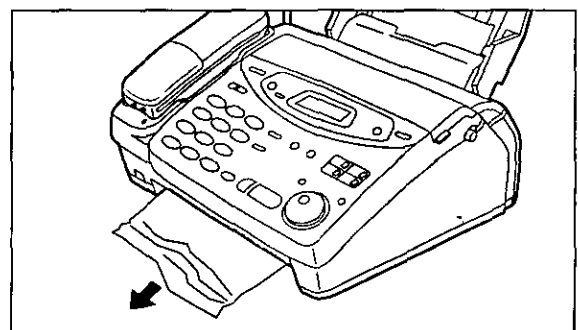
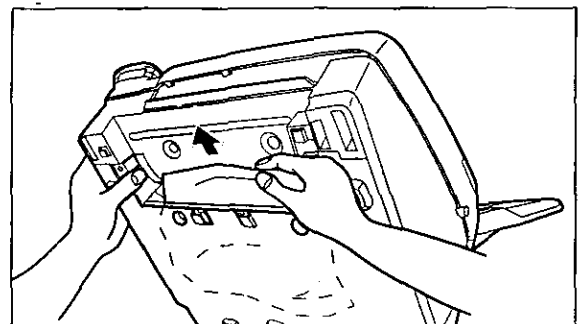

Sending document jams

If the unit does not release the document during feeding, remove the jammed document as follows.

- 1** Open the cover by pressing the cover open button.
- 2** Remove the jammed document carefully.
- 3** Close the cover securely by pushing down on the dotted area at both ends.

Note:

- Do not forcibly pull out the jammed paper before opening the cover.

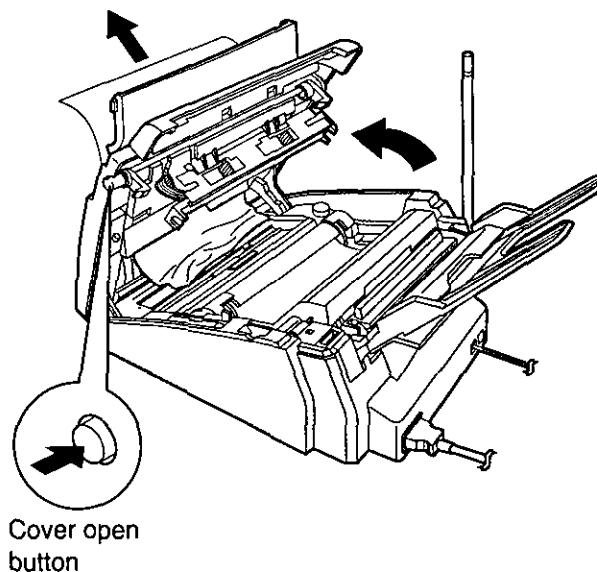
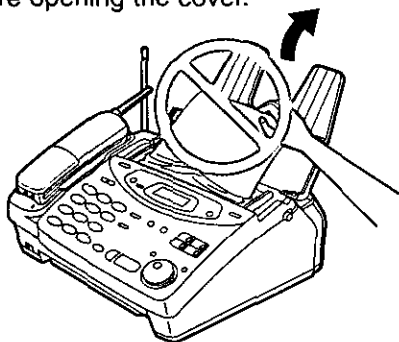

Jams

Sending document does not feed, or multi-feeds =====

If no feeding or multiple feeding occurs frequently, adjust the feeder pressure.

1 Open the cover by pressing the cover open button.

2 Shift the position of the green lever by using an instrument with a pointed end, such as a paper clip.

Left: When document multiple feeds.

Center: Standard position (pre-selected)

Right: When document does not feed.

3 Close the cover securely by pushing down on the dotted area at both ends.

Note:

- When shifting the green lever, do not touch the surrounding parts.

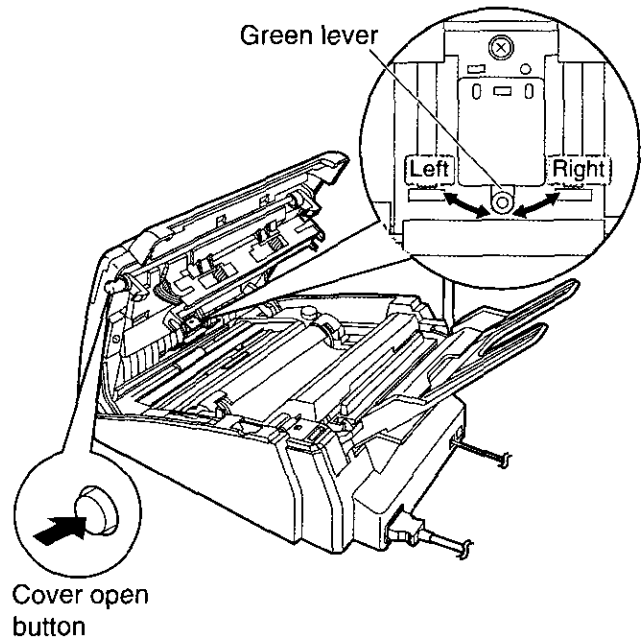

Replacing the handset battery

If the RECHARGE indicator flashes after being fully charged, replace the battery with a new Panasonic rechargeable battery Model No. KX-A36. To order see page 16. To prevent memory loss, replace the battery within 3 minutes.

- 1** Press down on the arrow and slide the handset cover.

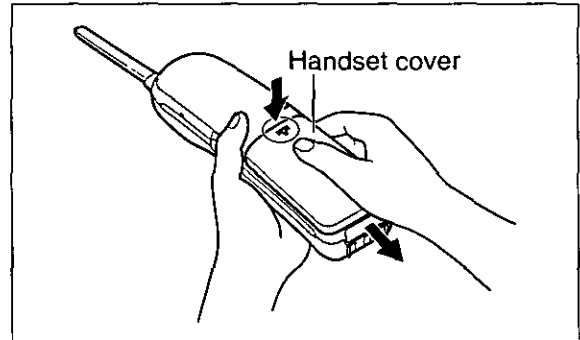

- 2** Disconnect the battery lead and remove the battery.

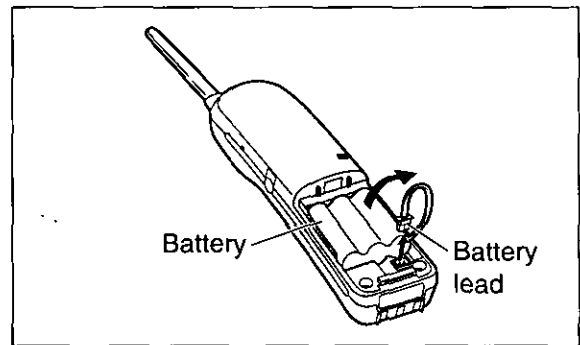

- 3** Connect the new battery lead and insert the battery into the handset.

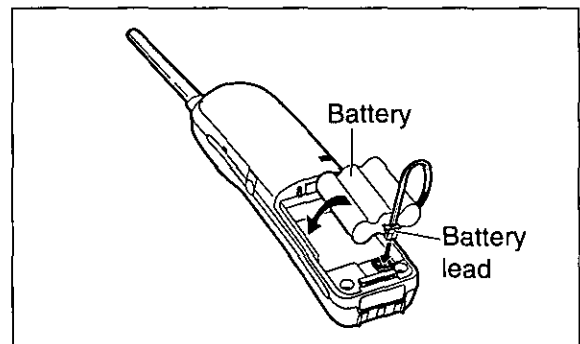

- 4** Replace the handset cover on the handset.
 - Be sure to charge the new battery for about 4 hours (p. 30).

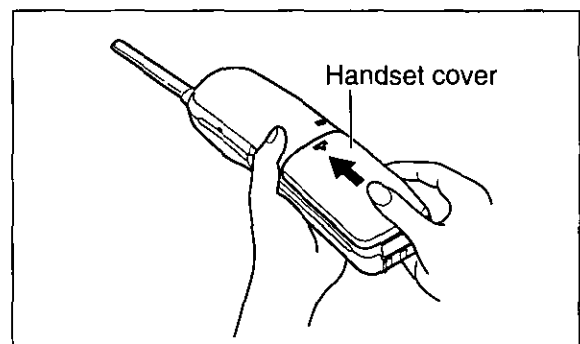

Attention:

- Use only a Panasonic rechargeable battery Model No. KX-A36.
- The product you have purchased is powered by a nickel cadmium battery which is recyclable. At the end of its useful life, under various state and local laws, it is illegal to dispose of this battery into your municipal waste stream. Please call 1-800-8-BATTERY for information on how to recycle this battery.



Ink Film

How much film you have left

To check the amount of remaining film, proceed as follows. The display indicates the approximate amount of remaining film.

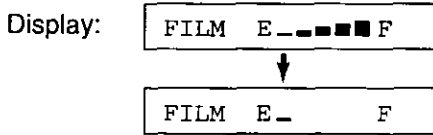

When the film indicator points to this position, the remaining film will print up to 25 pages of letter size document. Prepare a new film cartridge for replacement.

- 1 Press **MENU**.
Display:
- 2 Press **[]**, then **1** **8**.
- 3 Press **START/SET/COPY**.
Example:
- 4 Press **STOP**.
- 5 Press **MENU**.

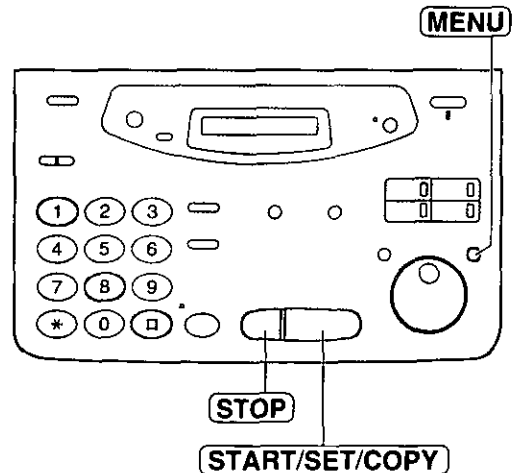

Replacing the film cartridge

When the unit detects the end of the film, the following message will be displayed.

Display: The remaining film prints about 15 pages of letter size document. Prepare a new film cartridge.

The film is empty. Install a new film cartridge.

The following is available for replacement:

KX-FA65: Film cartridge (prints about 330 letter size pages)

To order, see page 16.

- 1 Open the cover by pressing the cover open button.
- 2 Remove the used film cartridge.

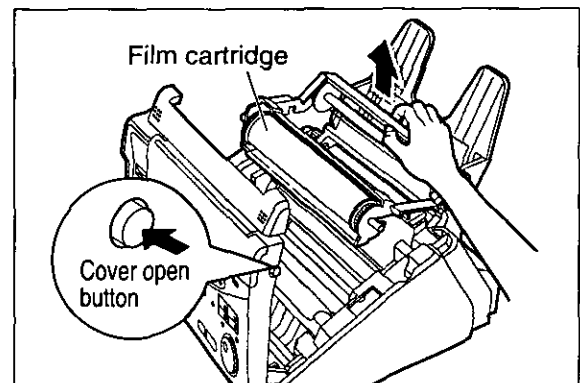

- 3** Remove the film stopper from the new film cartridge by pushing it up.

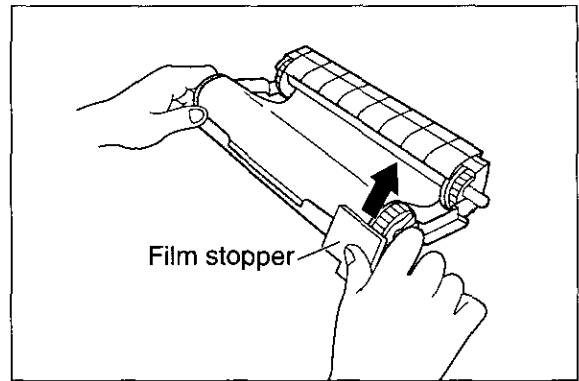

- 4** If the film is slack, tighten it by winding the gears.

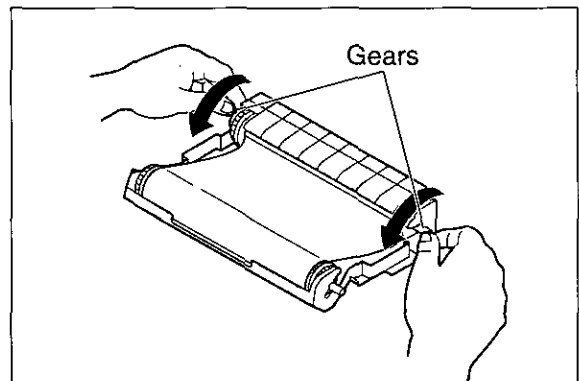
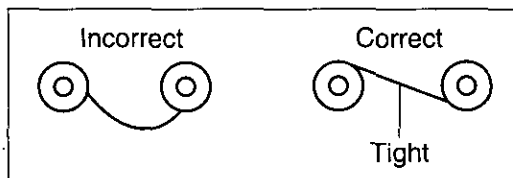

- 5** Turn the film cartridge over so that the "BACK" is facing up.

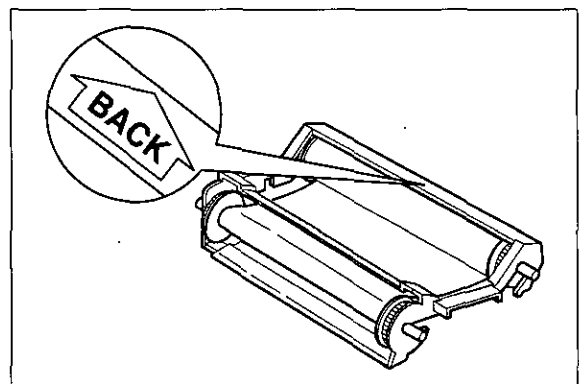

- 6** Insert the new film cartridge by first placing the front of the cartridge into the unit and then lowering the "BACK" of the cartridge into place.

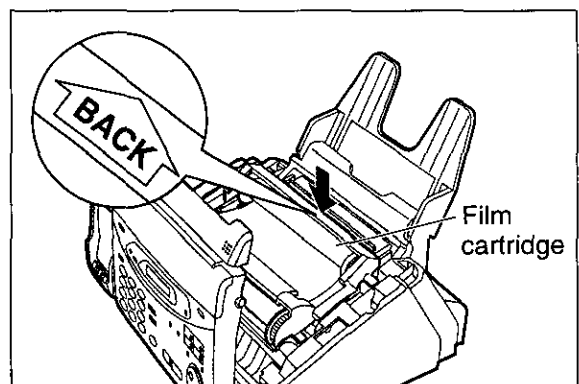

- 7** Close the cover securely by pushing down on the dotted area at both ends.

- The unit will check that there is no slack on the film. The following message will be displayed.

Display: PLEASE WAIT

Help

Cleaning

Document feeder

If misfeeding occurs frequently or if dirty patterns or black bands appear on a copied or transmitted document, clean the document feeder.

- 1** Disconnect the power cord and the telephone line cord.
- 2** Open the cover by pressing the cover open button.
- 3** Clean the document feeder rollers, sub roller and rubber flap with a cloth moistened with isopropyl rubbing alcohol, and let all parts dry thoroughly.
- 4** Clean the white plate and glass with a soft dry cloth.
- 5** Close the cover securely by pushing down on the dotted area at both ends.
- 6** Connect the power cord and the telephone line cord.

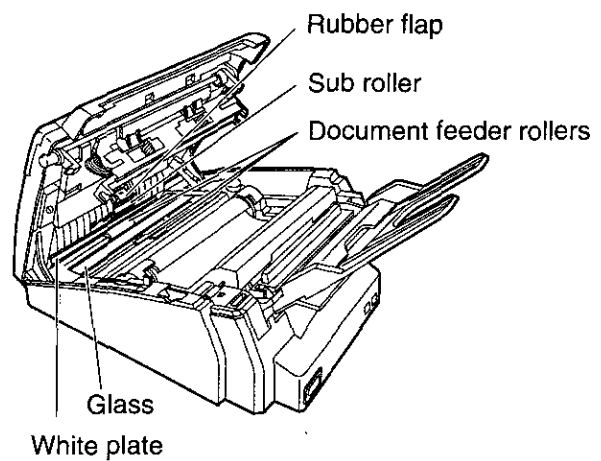
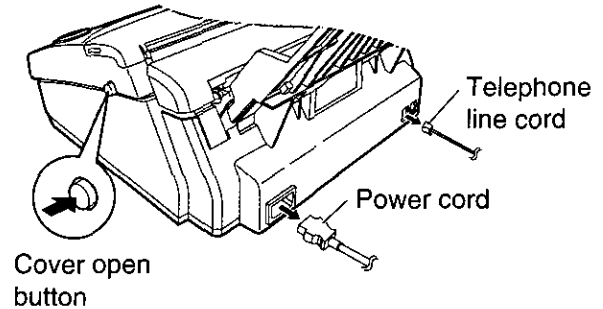

Caution:

- Do not use paper products, such as paper towels or tissues, to clean the inside of the unit.

Thermal head and black bar

If dirty patterns or black or white bands appear on a copied or received document, clean the thermal head and black bar.

- 1** Disconnect the power cord and the telephone line cord.
- 2** Open the cover by pressing the cover open button.
- 3** Clean the thermal head and black bar with a cloth moistened with isopropyl rubbing alcohol, and let it dry thoroughly.
- 4** Close the cover securely by pushing down on the dotted area at both ends.
- 5** Connect the power cord and the telephone line cord.

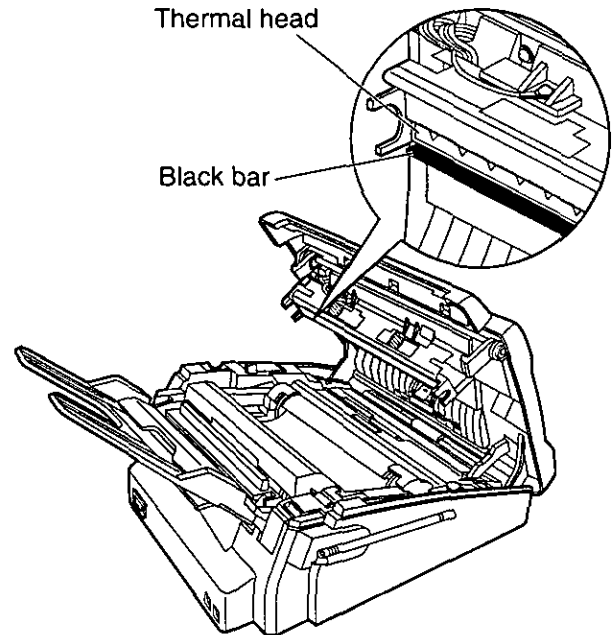

Caution:

- To prevent a malfunction due to static electricity, do not use a dry cloth and do not touch the thermal head directly with your fingers.

Help

Cleaning

Charge contacts

Clean the charge contacts with a dry soft cloth once a month, or the battery may not charge properly.

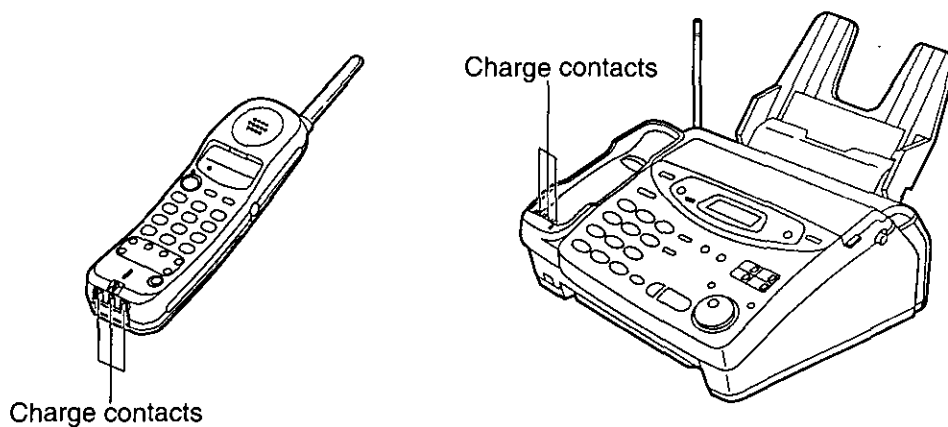

Printing the feature settings, telephone numbers, journal, printer test list, broadcast list and Caller ID list

You can print out the following lists/reports.

Feature list: provides you with the current settings of the basic and advanced programming features (p. 126, 127).

Telephone number list: provides you with the names and telephone numbers which are stored in the One-Touch Dial and JOG DIAL directory. The telephone number codes are as shown below.

P: A pause has been entered.

[]: A secret telephone number has been entered. (The telephone number is not printed.)

Journal report: keeps records of fax transmissions and receptions. This report will be printed automatically after every 35 fax communications (p. 61).

Printer test list: allows you to check the print quality of your unit. If the test print has a dirty pattern, or blurred points or lines, clean the thermal head (p. 107).

Broadcast list: provides you with the names and telephone numbers which are stored in the BROADCAST keys (p. 64–66).

Caller ID list: keeps records of the last 35 callers after subscribing to a Caller ID service. Also, this report will be printed automatically after every 35 callers (p. 51).

1 Press **MENU** two times.

Display: 2.PRINT REPORT

2 For the **feature list**, press **[]**, then **1**.

SETUP LIST

For the **telephone number list**, press **[]**, then **3**.

TEL NO. LIST

For the **journal report**, press **[]**, then **4**.

JOURNAL REPORT

For the **printer test list**, press **[]**, then **5**.

PRINTER TEST

For the **broadcast list**, press **[]**, then **6**.

BROADCAST LIST

For the **Caller ID list**, press **[]**, then **8**.

CALLER ID LIST

3 Press **START/SET/COPY** to start printing.

PRINTING

- To stop printing, press **STOP**.

- After printing, the following will be displayed.

PRINT ITEM []

4 Press **MENU**.

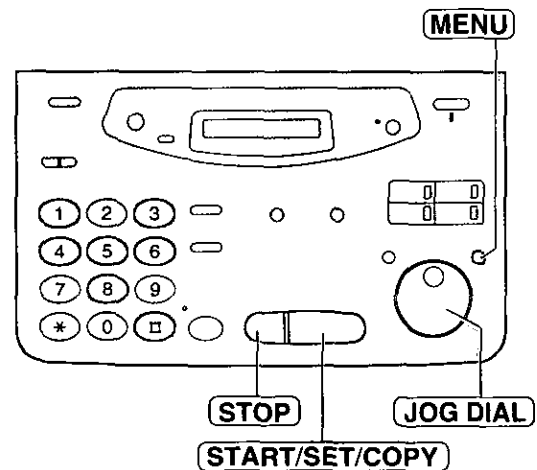

Note:

- In step 2, you can select the desired item by rotating **JOG DIAL**.

Display Contrast / Reset

Changing the display contrast

Use this feature to adjust the display contrast.

NORMAL: (Pre-selected setting)

DARKER: Used when the display contrast is too light.

- 1 Press **MENU**.
Display: 1.SYSTEM SET UP
- 2 Press **▣**, then **3** **9**.
LCD CONTRAST
- 3 Press **START/SET/COPY**.
MODE=NORMAL ▼▲
- 4 Press ▼ or ▲ to select the desired setting.
- 5 Press **START/SET/COPY**.
SETUP ITEM []
- 6 Press **MENU**.

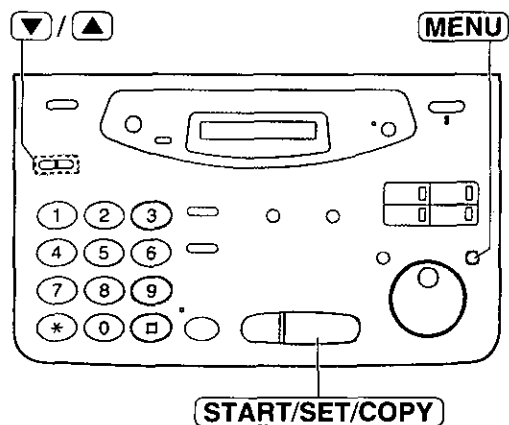

Resetting the advanced features

Use this feature to return the advanced features (p. 126, 127) to their pre-selected settings.

- 1 Press **MENU**.
Display: 1.SYSTEM SET UP
- 2 Press **▣**, then **8** **0**.
SET DEFAULT
- 3 Press **START/SET/COPY**.
RESET=NO ▼▲
- 4 Press ▼ or ▲ to select "YES".
RESET=YES ▼▲
- 5 Press **START/SET/COPY**.
RESET OK?
- If this feature is not required, press **STOP**.
- 6 Press **START/SET/COPY** again for confirmation.
RESET COMPLETED
↓
SETUP ITEM []
- 7 Press **MENU**.

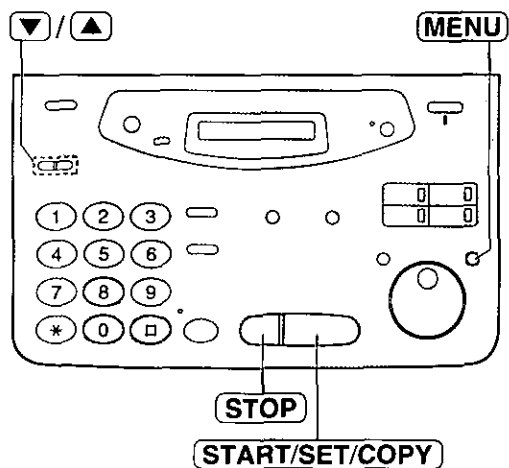

List of FCC requirements and information --- ---

If required by the telephone company, inform them of the following.

- FCC Registration No.:
(found on the rear of the unit)
- Ringer Equivalence No.:
(found on the rear of the unit)
- The particular telephone line to which the equipment is connected.

This unit must not be connected to a coin operated line. If you are on a party line, check with your local telephone company.

Ringer Equivalence Number (REN):

This REN is useful in determining the quantity of devices you may connect to your telephone line and still have all of those devices ring when your telephone number is called. In most but not all areas, the sum of the REN's of all devices connected to one line should not exceed five (5.0). To be certain of the number of devices you may connect to your line, as determined by the REN, you should contact your local telephone company to determine the maximum REN for your calling area.

In the event that terminal equipment causes harm to the telephone network, the telephone company should notify the customer, if possible, that service may be stopped. However, where prior notice is impractical, the company may temporarily cease service providing that they:

- a) Promptly notify the customer.
- b) Give the customer an opportunity to correct the problem with their equipment.
- c) Inform the customer of the right to bring a complaint to the Federal Communication Commission pursuant to procedures set out in FCC Rules and Regulations Subpart E of Part 68.

The Telephone Company may make changes in its communications facilities, equipment operations, or procedures where such action is reasonably required in the operation of its business and is not inconsistent with the rules and regulations in FCC Part 68. If such changes can be reasonably expected to render any customer terminal equipment incompatible with telephone company communications facilities, or require modification or

alteration of such terminal equipment, or otherwise materially affect its use or performance, the customer shall be given adequate notice in writing, to allow the customer an opportunity to maintain uninterrupted service.

CAUTION:

Any changes or modifications not expressly approved by the party responsible for compliance could void the user's authority to operate this device.

When programming emergency numbers and/or making test calls to emergency numbers:

1. Remain on the line and briefly explain to the dispatcher the reason for the call before hanging up.
2. Perform such activities in the off-peak hours; such as early morning or late evenings.

This telephone provides magnetic coupling to hearing aids.

NOTE:

This equipment has been tested and found to comply with the limits for a Class B digital device, pursuant to Part 15 of the FCC Rules. These limits are designed to provide reasonable protection against harmful interference in a residential installation. This equipment generates, uses, and can radiate radio frequency energy and, if not installed and used in accordance with the instructions, may cause harmful interference to radio communications. However, there is no guarantee that interference will not occur in a particular installation. If this equipment does cause harmful interference to radio or television reception, which can be determined by turning the equipment off and on, the user is encouraged to try to correct the interference by one or more of the following measures:

- Reorient or relocate the receiving antenna.
- Increase the separation between the equipment and receiver.
- Connect the equipment into an outlet on a circuit different from that to which the receiver is connected.
- Consult the dealer or an experienced radio/TV technician for help.

Limited Warranty

Panasonic Consumer Electronics Company,
Division of Matsushita Electric Corporation of America
One Panasonic Way, Secaucus,
New Jersey 07094

Panasonic Sales Company
Division of Matsushita Electric of
Puerto Rico, Inc.
Ave. 65 de Infantería, Km. 9.5, San Gabriel
Industrial Park, Carolina, Puerto Rico 00985

PANASONIC Facsimile Products Limited Warranty

Have any questions? CALL 1-800-HELPFAX on:

How to operate the unit,
How to get repair service,
How to get supplies.

Panasonic Consumer Electronics Company or Panasonic Sales Company (collectively referred to as "the warrantor"), will repair this product with new or refurbished parts, free of charge, in the USA or Puerto Rico for one (1) year from the date of original purchase in the event of a defect in materials or workmanship.

This Limited Warranty Excludes both Labor and Parts for: batteries, antennas, and cosmetic parts (cabinet).

Carry-in or mail-in service in the USA or Puerto Rico can be obtained during the warranty period by contacting a Panasonic Services Company (PASC) Factory Servicenter listed in the Servicenter Directory. Or call, toll free, 1-800-HELP FAX (1-800-435-7329) to locate a PASC Factory Servicenter. Carry-in or mail-in service in Puerto Rico can be obtained during the warranty period by calling the Panasonic Sales Company telephone number listed in the Servicenter Directory.

This warranty is extended only to the original purchaser. A purchase receipt or other proof of date of original purchase will be required before warranty service is rendered.

This warranty only covers failures due to defects in material or workmanship which occur during normal use and (when applicable) does not cover the film cartridge, the toner cartridge and drum unit or the print and ink cartridge. The inability of this product to interface with any specific computer is not a manufacturing defect and is outside of the scope of this Limited Warranty. In no event shall the warrantor be liable by reason of such incompatibility. The warranty does not cover damages which occur in shipment, or failures which are caused by products not supplied by the warrantor such as non Panasonic ink cartridges, or failures which result from accident, misuse, abuse, neglect, mishandling, faulty installation, misapplication, set-up adjustments, improper operation or maintenance, alteration, modification, power line surge, improper voltage supply, lightning damage, signal reception problems, rental use of the product, or service by anyone other than a PASC Factory Servicenter or a PASC authorized Servicenter, or damage that is attributable to acts of God.

LIMITS AND EXCLUSIONS

There are no express warranties except as listed above.

THE WARRANTOR SHALL NOT BE LIABLE FOR INCIDENTAL OR CONSEQUENTIAL DAMAGES RESULTING FROM THE USE OF THIS PRODUCT, OR ARISING OUT OF ANY BREACH OF THIS WARRANTY. ALL EXPRESS AND IMPLIED WARRANTIES, INCLUDING THE WARRANTIES OF MERCHANTABILITY, ARE LIMITED TO THE APPLICABLE WARRANTY PERIOD SET FORTH ABOVE.

Some states do not allow the exclusion or limitation of incidental or consequential damages, or limitations on how long an implied warranty lasts, so the above exclusions or limitations may not apply to you.

This warranty gives you specific legal rights and you may also have other rights which vary from state to state. If a problem with this product develops during or after the warranty period, you may contact your dealer or Servicenter. If the problem is not handled to your satisfaction, then write to the Customer Satisfaction Center at the company address indicated above.

Servicenter Directory

**For Product Information, Operating Assistance, Literature Request, Dealer Locations, and all Customer Service inquiries please contact:
1-800-HELP-FAX (435-7329), Monday-Friday 9am - 8pm EST.**

**Web Site: <http://www.Panasonic.com>
You can purchase parts, accessories or locate your nearest servicenter by visiting our Web Site.**

Factory Servicenters Locations

<p>CALIFORNIA 6550 Katella Avenue Cypress, CA 90630</p> <p>800 Dubuque Avenue S. San Francisco, CA 94080</p> <p>20201 Sherman Way Suite 102 Canoga Park, CA 91306</p> <p>3878 Ruffin Road Suite A San Diego, CA 92123</p> <p>COLORADO 1640 South Abilene Street Suite D Aurora, CO 80012</p> <p>FLORIDA 3700 North 29th Avenue Suite 102 Hollywood, FL 33020</p>	<p>GEORGIA 8655 Roswell Road Suite 100 Atlanta, GA 30350</p> <p>ILLINOIS 9060 Golf Road Niles, IL 60714</p> <p>1703 North Randall Road Elgin, IL 60123 (Pick-up / Drop-off only)</p> <p>MARYLAND 62 Mountain Road Glen Burnie, MD 21061</p> <p>MASSACHUSETTS 60 Glacier Drive Suite G Westwood, MA 02090</p>	<p>MICHIGAN 37048 Van Dyke Avenue Sterling Heights, MI 48312</p> <p>MINNESOTA 7850-12th Avenue South Airport Business Center Bloomington, MN 55425</p> <p>OHIO 2236 Waycross Road Civic Center Plaza Forest Park, OH 45240</p> <p>PENNSYLVANIA 2221 Cabot Blvd. West Suite B Langhorne, PA 19047</p> <p>Chartiers Valley Shopping Center 1025 Washington Pike Bridgeville, PA 15017</p>	<p>TENNESSEE 3800 Ezell Road Suite 806 Nashville, TN 37211</p> <p>TEXAS 7482 Harwin Drive Houston, TX 77036</p> <p>13615 Welch Road Suite #101 Farmers Branch, TX 75244</p> <p>WASHINGTON 20425-84th Avenue South Kent, WA 98032</p> <p>HAWAII 99-859 Iwaiwa Street Aiea, Hawaii 96701 Phone (808) 488-1996 Fax (808) 486-4369</p>
--	--	--	---

Service in Puerto Rico

Matsushita Electric of Puerto Rico, Inc. Panasonic Sales Company/ Factory Servicenter:
Ave. 65 de Infantería, Km. 9.5, San Gabriel Industrial Park, Carolina, Puerto Rico 00985
Phone (787) 750-4300 Fax (787) 768-2910

Accessory Purchases:

1-800-332-5368 (Customer Orders Only)
Panasonic Services Company 20421 84th Avenue South, Kent, WA 98032
(6 am to 5 pm Monday – Friday; 6 am to 10:30 am Saturday; PST)
(Visa, MasterCard, Discover Card, American Express, Check)

Limited Warranty / Energy Star

Notes for product service and shipping the product

For product service

- Servicenters are listed on page 113.
- Call toll free 1-800-HELP-FAX (435-7329) for the location of an authorized servicenter.

When you ship the product

- Carefully pack your unit, preferably in the original carton.
- Attach a letter, detailing the symptom or problem, to the outside of the carton.
- Send the unit to an authorized servicenter, prepaid and adequately insured.
- Do not send your unit to the Panasonic Consumer Electronics Company or to any executive or regional sales offices. These locations do not repair consumer products.

Energy Star

As an ENERGY STAR® Partner, Panasonic has determined that this product meets the ENERGY STAR® guidelines for energy efficiency.

ENERGY STAR is a U.S. registered mark.



Technical data about this product

■ Main unit

Applicable Lines:	Public Switched Telephone Network
Document Size:	Max. 216 mm (8½") in width Max. 600 mm (23⅝") in length
Effective Scanning Width:	208 mm (8⅜")
Recording Paper Size:	Letter: 216 mm × 279 mm (8½" × 11") Legal: 216 mm × 356 mm (8½" × 14")
Effective Printing Width:	208 mm (8⅜")
Transmission Time*:	Approx. 15 s/page (Original mode)**
Scanning Density:	Horizontal: 8 pels/mm (203 pels/inch) Vertical: 3.85 lines/mm (98 lines/inch) —STANDARD mode 7.7 lines/mm (196 lines/inch) —FINE/HALF TONE mode 15.4 lines/mm (392 lines/inch) —SUPER FINE mode
Halftone Level:	64-level
Scanner Type:	Contact Image Sensor (CIS)
Printer Type:	Thermal Printing
Data Compression System:	Modified Huffman (MH), Modified READ (MR)
Modem Speed:	9,600 / 7,200 / 4,800 / 2,400 bps; Automatic Fallback
Operating Environment:	5 °C – 35 °C (41 °F – 95 °F), 20 % – 80 % RH (Relative Humidity)
Dimensions (H × W × D):	143 mm × 345 mm × 305 mm (5⅝" × 12⅜" × 12")
Mass (Weight):	Approx. 4.4 kg (9.7 lb.)
Power Consumption:	Standby: Approx. 11 W Transmission: Approx. 18 W Reception: Approx. 42 W (When receiving a 20% black document) Copy: Approx. 48 W (When copying a 20% black document) Maximum: Approx. 160 W (When copying a 100% black document)
Power Supply:	120 V AC, 60 Hz (This unit will not function at 50 Hz.)
Memory Capacity:	Approx. 28 pages of memory reception Approx. 25 pages of memory transmission (Based on the CCITT of No. 1 Test Chart in standard resolution.)

■ Handset

Operating Environment:	5 °C – 35 °C (41 °F – 95 °F), 45 % – 85 % RH (Relative Humidity)
Dimensions (H × W × D):	Approx. 39 mm × 55 mm × 271 mm (1⅞" × 2⅝" × 10⅞")
Mass (Weight):	Approx. 200 g (0.4 lb.)
Power Supply:	Ni-Cd battery (3.6 V, 600 mAh)
Frequency:	926 MHz–927 MHz, 902 MHz–903 MHz (30 channels)
Security Codes:	1,000,000

* Transmission speed depends upon the contents of the pages, resolution, telephone line conditions and capability of the receiving unit.

** The 15 second speed is based upon the CCITT No. 1 Test Chart and original mode.
If the capability of the other party's machine is inferior to your unit, the transmission time may be longer.

Note:

- Any details given in these instructions are subject to change without notice.
- The pictures and illustrations in these instructions may vary slightly from the actual product.

CCITT No. 1 Test Chart

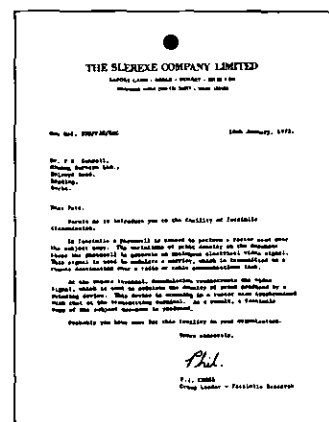

General Information

Comienzo rápido en español

Instalación

Antes de hacer la instalación

A. Quite la cinta de transporte.



B. Abra la cubierta, quite un folleto de debajo del cartucho de película y cierre la cubierta.

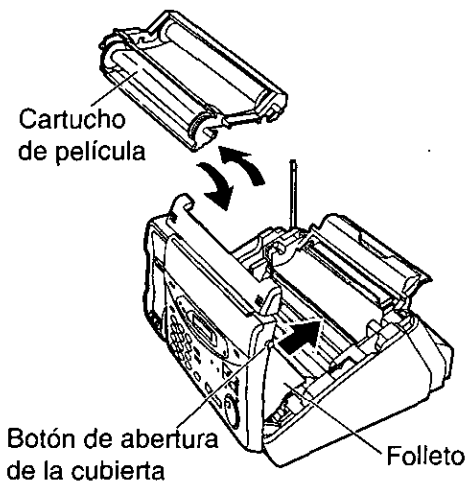

Bandeja de papel

Inserte las dos lengüetas de la bandeja de papel en las ranuras de la parte trasera de la unidad.

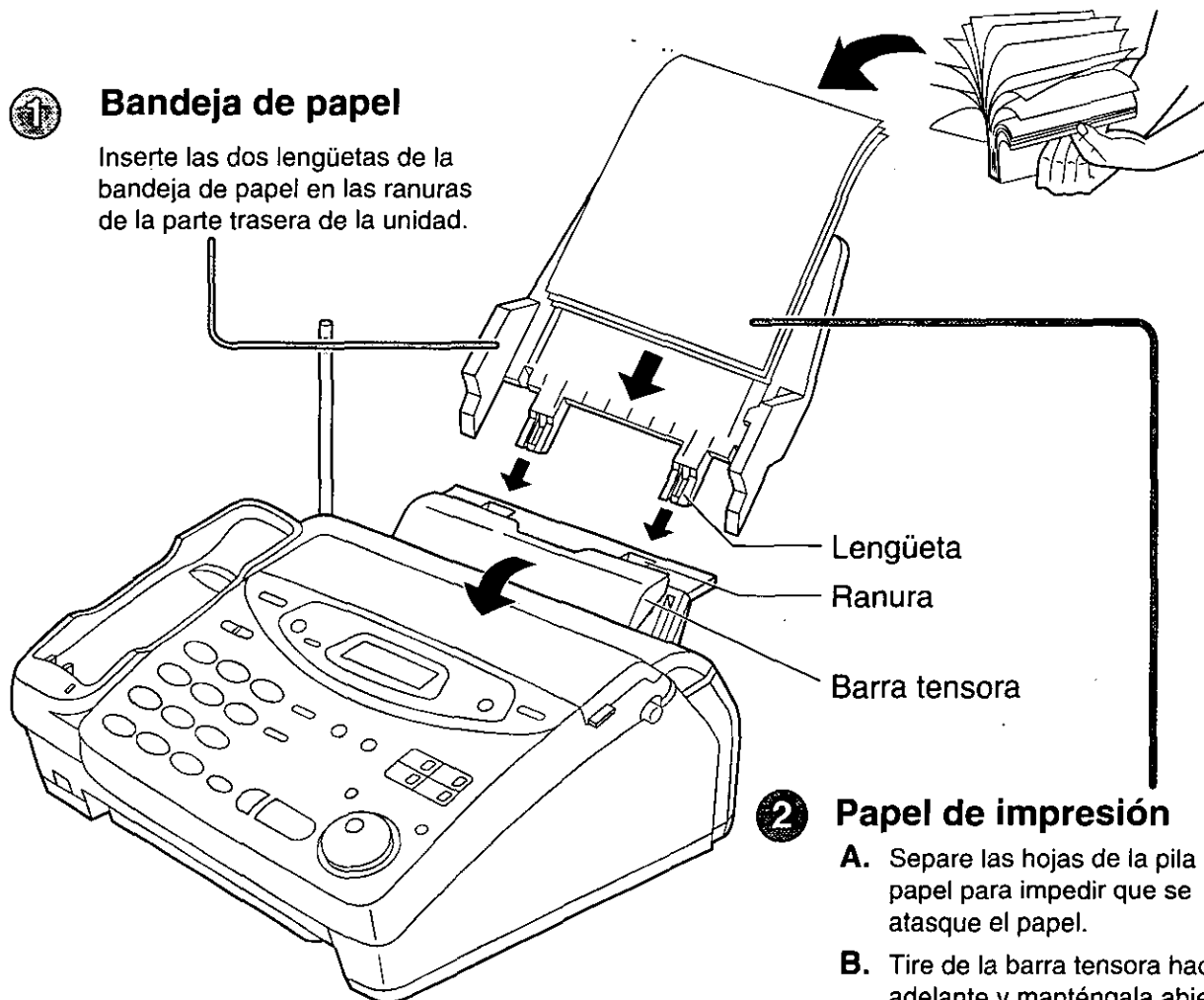

2 Papel de impresión

A. Separe las hojas de la pila de papel para impedir que se atasque el papel.

B. Tire de la barra tensora hacia adelante y manténgala abierta mientras introduce el papel.

Conexiones

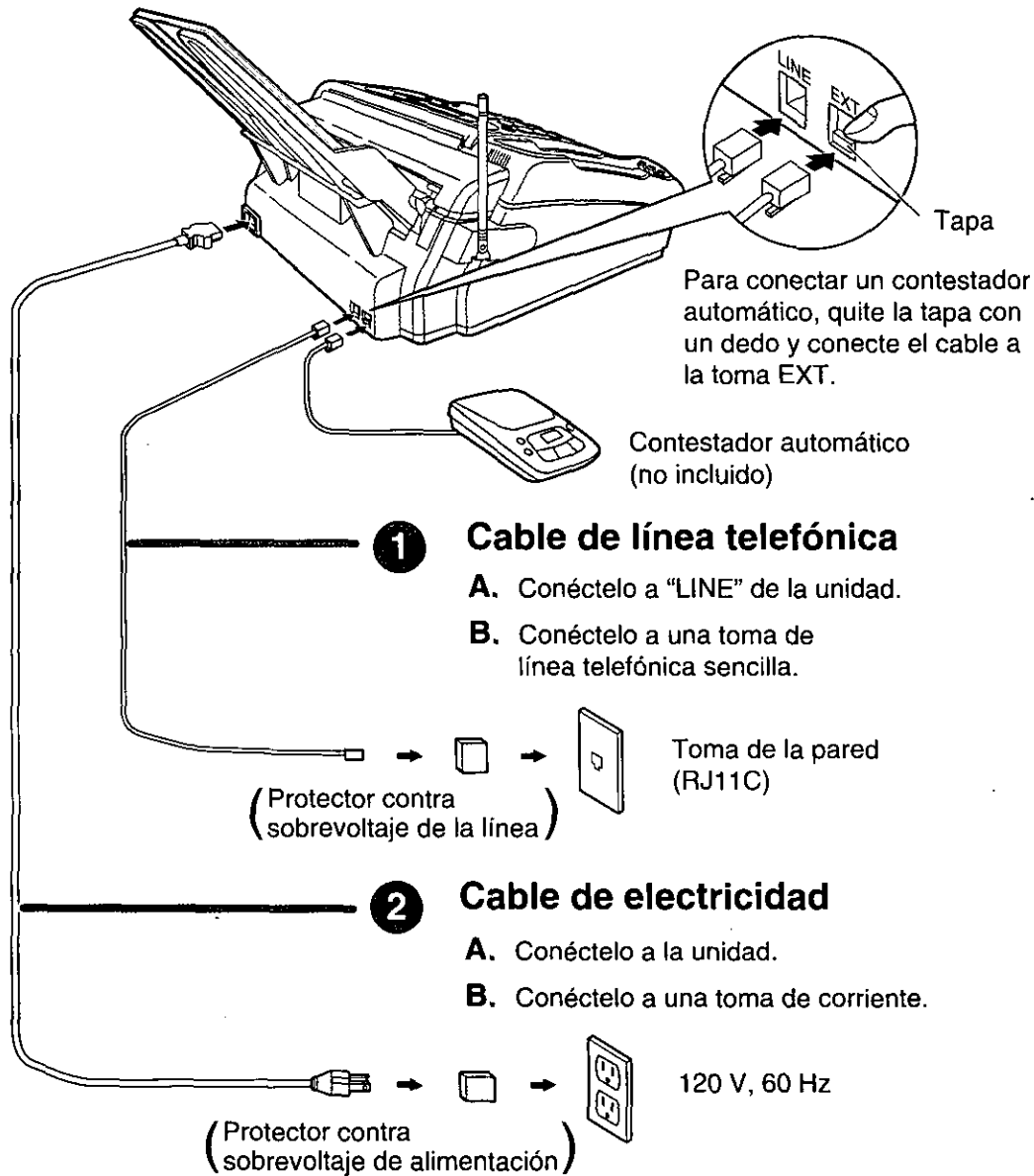

Carga de la batería para la unidad portátil

Para utilizar la unidad portátil, cargue la batería durante unas **4 horas** antes de utilizarlo por primera vez.

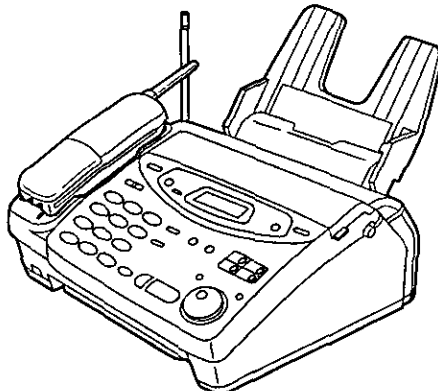

Programación inicial

■ Ajuste de la fecha y la hora

- ① Pulse **MENU**.
- ② Pulse **□**, y luego **0 1**.
- ③ Pulse **START/SET/COPY**.
- ④ Introduzca el mes/día/año correcto seleccionándolos con 2 dígitos para cada uno utilizando el teclado de marcación o **JOG DIAL**. Si utiliza **JOG DIAL**, pulse **▶** para mover el cursor.
- ⑤ Pulse **START/SET/COPY**.
- ⑥ Introduzca la hora/minuto correcto seleccionando cada uno de ellos mediante 2 dígitos con el teclado de marcación o **JOG DIAL**. Si utiliza **JOG DIAL**, pulse **▶** para mover el cursor.
Pulse ***** para seleccionar "AM" o "PM".
- ⑦ Pulse **START/SET/COPY**.
- ⑧ Pulse **MENU**.

■ Ajuste de su logotipo

- ① Pulse **MENU**.
- ② Pulse **□**, y luego **0 2**.
- ③ Pulse **START/SET/COPY**.
- ④ Introduzca su logotipo, con un máximo de 30 caracteres, utilizando el teclado de marcación (consulte las instrucciones de la derecha) o **JOG DIAL** (consulte la página 120).
 - Para introducir continuamente el mismo número, pulse **▶** para mover el cursor al siguiente espacio.
- ⑤ Pulse **START/SET/COPY**.
- ⑥ Pulse **MENU**.

■ Ajuste del número de teléfono de su facsímil

- ① Pulse **MENU**.
- ② Pulse **□**, y luego **0 3**.
- ③ Pulse **START/SET/COPY**.
- ④ Introduzca el número de teléfono de su facsímil con un máximo de 20 dígitos utilizando el teclado de marcación o **JOG DIAL**. Si utiliza **JOG DIAL**, pulse **▶** para mover el cursor.
 - El botón ***** reemplaza un carácter por un signo "+" y el botón **□** reemplaza un carácter por un espacio.
 - Para introducir un guión en un número de teléfono, pulse **HYPHEN**.
- ⑤ Pulse **START/SET/COPY**.
- ⑥ Pulse **MENU**.

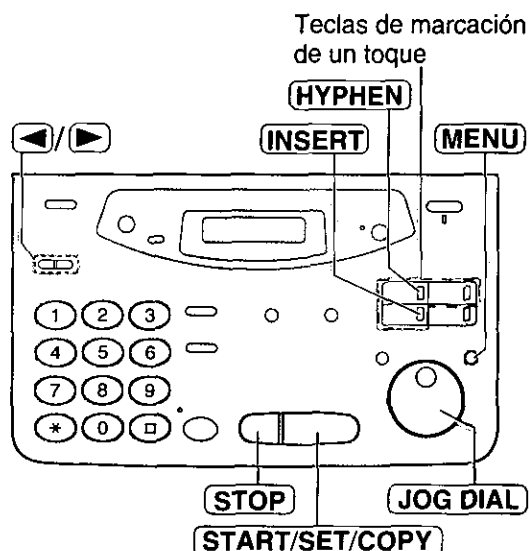

Selección de caracteres con el teclado de marcación

Tecla	Caracteres
①	1 [] { } + - / = · - ` : ; ?
②	A B C a b c 2
③	D E F d e f 3
④	G H I g h i 4
⑤	J K L j k l 5
⑥	M N O m n o 6
⑦	P Q R S p q r s 7
⑧	T U V t u v 8
⑨	W X Y Z w x y z 9
⑩	0 () < > ! " # \$ % & ¥ * @ ^ ' →
INSERT	Se utiliza para insertar un carácter o un espacio.

Para corregir un error

- Pulse **◀** o **▶** para mover el cursor al carácter incorrecto, y luego haga la corrección.
- Para borrar un carácter, mueva el cursor al carácter que desee borrar y pulse **STOP** para las características número #02 y #03.

Marcación automática (unidad portátil)

En la unidad portátil usted puede memorizar un máximo de 10 números de teléfono. Las teclas de marcación (0 a 9) funcionan como estaciones de memoria. Asegúrese de que el indicador TALK esté apagado.

■ Memorización de números de teléfono

- 1 Pulse **PROGRAM**.
- 2 Introduzca el número de teléfono de hasta 22 dígitos.
- 3 Pulse **AUTO**.
- 4 Pulse un número de estación de memoria (0 a 9).

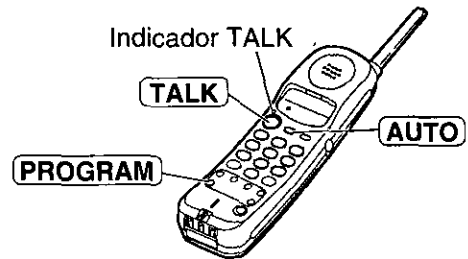

■ Para hacer una llamada de voz utilizando números memorizados

- 1 Pulse **TALK**.
- 2 Pulse **AUTO**.
- 3 Pulse el número de estación de memoria deseado (0 a 9).
- 4 Cuando termine de conversar, pulse **TALK**.

Memorización de nombres y números de teléfono en el directorio JOG DIAL

Para acceder rápidamente a los números marcados frecuentemente, además de la marcación de un toque, la unidad proporciona también el directorio JOG DIAL (100 estaciones).

- 1 Pulse **DIRECTORY PROGRAM**.
- 2 Gire **JOG DIAL** e introduzca el nombre, hasta 10 caracteres, utilizando el teclado de marcación (consulte la página 118) o **JOG DIAL** (consulte la página 120).
- 3 Pulse **START/SET/COPY**.
- 4 Introduzca el número de teléfono, un máximo de 30 dígitos.
- 5 Pulse **START/SET/COPY**.
- 6 Pulse **DIRECTORY PROGRAM** para salir de la programación.

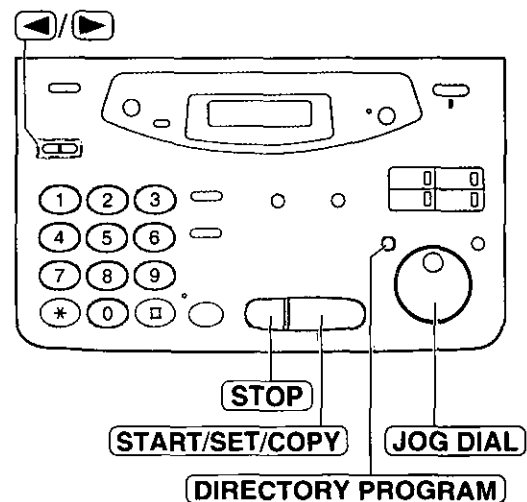

Para corregir un error

- Pulse **◀** o **▶** para mover el cursor al carácter incorrecto, y luego haga la corrección.

Para borrar un carácter

- Mueva el cursor al carácter que desee borrar y pulse **STOP**.

Memorización de nombres y números de teléfono para la marcación de un toque

- ① Pulse **DIRECTORY PROGRAM**.
- ② **Para las estaciones 1-3**
Pulse una de las teclas de marcación de un toque.
 - Si selecciona la tecla de marcación de un toque 1, 2 ó 3, seleccione "DIAL MODE" pulsando **▼**, y luego pulse **START/SET/COPY** para ir a la siguiente indicación.**Para las estaciones 4-6**
Pulse **LOWER**, y luego pulse una de las teclas de marcación de un toque.
- ③ Introduzca el nombre de la estación, un máximo de 10 caracteres, utilizando el teclado de marcación (consulte la página 118) o **JOG DIAL** (consulte abajo).
- ④ Pulse **START/SET/COPY**.
- ⑤ Introduzca el número de teléfono, un máximo de 30 dígitos.
- ⑥ Pulse **START/SET/COPY**.
- ⑦ Pulse **DIRECTORY PROGRAM** para salir de la programación.

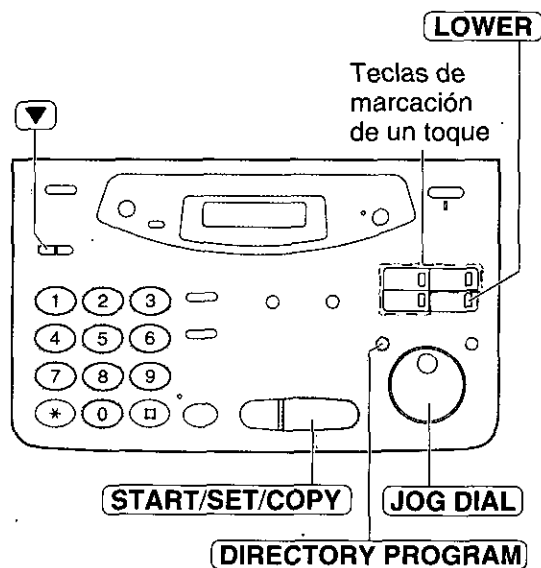

Selección de caracteres con JOG DIAL

En lugar de pulsar las teclas de marcación podrá seleccionar caracteres utilizando JOG DIAL.

1. Gire **JOG DIAL** hasta que se visualice el carácter deseado.
2. Pulse **▶** para mover el cursor al siguiente espacio.
 - Se inserta el carácter visualizado en el paso 1.
3. Vuelva al paso 1 para introducir el siguiente carácter.

Orden de visualización de los caracteres

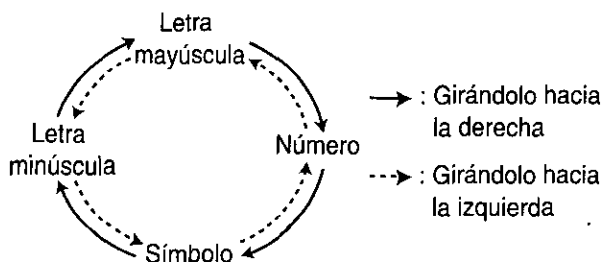

Para hacer/contestar una llamada de voz

■ Para hacer manualmente una llamada de voz

- 1 Pulse **TALK**.
- 2 Marque el número de teléfono.
- 3 Cuando termine de conversar, pulse **TALK** o vuelva a poner la unidad portátil en su lugar.

■ Para hacer una llamada de voz utilizando la marcación de un toque

- 1 Pulse **MONITOR**.
- 2 **Para las estaciones 1-3**
Pulse la tecla de marcación de un toque deseada.
Para las estaciones 4-6
Pulse **LOWER**, y luego pulse la tecla de marcación de un toque deseada.
- 3 Cuando conteste la otra persona, pulse **TALK** en la unidad portátil.
- 4 Cuando termine de conversar, pulse **TALK** o vuelva a poner la unidad portátil en su lugar.

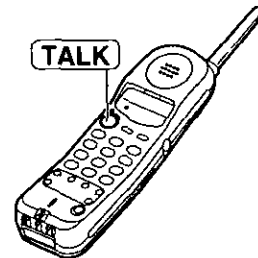
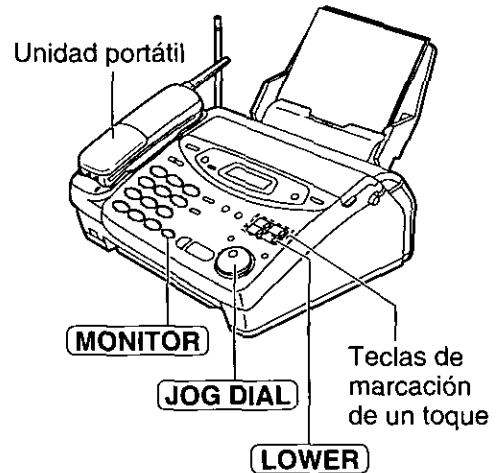

■ Para hacer una llamada de voz utilizando el directorio JOG DIAL

- 1 Gire **JOG DIAL** hasta que se visualice el nombre deseado.
- 2 — Cuando la unidad portátil no esté en la unidad principal:
Pulse **TALK** en la unidad portátil.
— Cuando la unidad portátil esté en la unidad principal:
Levante la unidad portátil.
 - La unidad empezará a marcar automáticamente.
- 3 Cuando termine de conversar, pulse **TALK** o vuelva a poner la unidad portátil en su lugar.

■ Para contestar una llamada de voz

- 1 Cuando la unidad suene, conteste la llamada.
 - Cuando la unidad portátil no esté en la unidad principal:
Pulse **TALK** en la unidad portátil.
 - Cuando la unidad portátil esté en la unidad principal:
Levante la unidad portátil.
- 2 Cuando termine de conversar, pulse **TALK** o vuelva a poner la unidad portátil en su lugar.

Comienzo rápido en español

Envío de un fax

■ Envío manual de un fax

- 1 Abra la bandeja del alimentador de documentos.
- 2 Ajuste la anchura de las guías de documentos según el tamaño del documento.
- 3 Introduzca el documento hasta que oiga un pitido.
- 4 Marque el número del fax.
- 5 Pulse **START/SET/COPY**.

■ Envío de un fax utilizando la marcación de un toque

- 1 Abra la bandeja del alimentador de documentos.
- 2 Ajuste la anchura de las guías de documentos según el tamaño del documento.
- 3 Introduzca el documento hasta que oiga un pitido.
- 4 **Para las estaciones 1-3**
Pulse la tecla de marcación de un toque deseada.
Para las estaciones 4-6
Pulse **LOWER**, y luego pulse la tecla de marcación de un toque deseada.

■ Envío de un fax utilizando el directorio JOG DIAL

- 1 Abra la bandeja del alimentador de documentos.
- 2 Ajuste la anchura de las guías de documentos según el tamaño del documento.
- 3 Introduzca el documento hasta que oiga un pitido.
- 4 Gire **JOG DIAL** hasta que se visualice el nombre deseado.
- 5 Pulse **START/SET/COPY**.

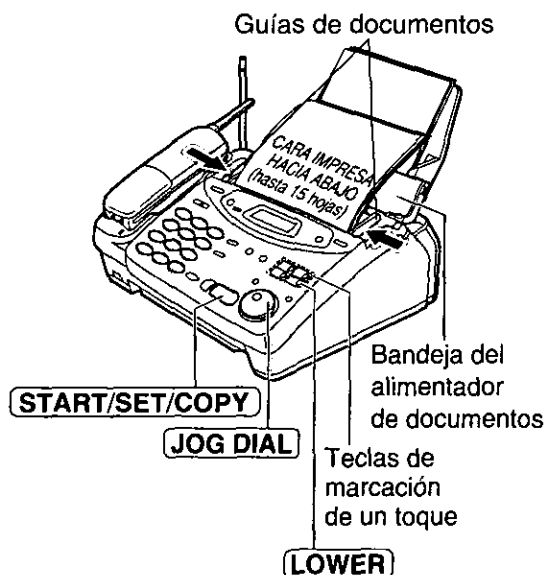

Recibiendo un fax

■ Recepción manual de un fax

- 1 Levante la unidad portátil cuando oiga el timbre de la unidad.
- 2 Cuando:
 - sea necesario recibir un documento,
 - se oiga un tono de llamada de fax (pitido lento), o
 - no se oiga sonido,pulse **START/SET/COPY** en la unidad principal o pulse firmemente **FAX** en la unidad portátil hasta que oiga un pitido.
- 3 Cuelgue la unidad portátil.

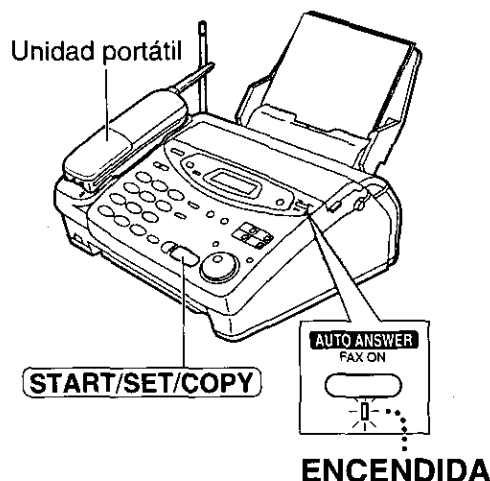

■ Recepción automática de un fax

Pulse **AUTO ANSWER** para activar el modo AUTO ANSWER.

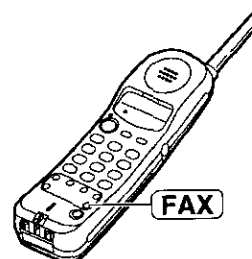

Para hacer una copia

- 1 Abra la bandeja del alimentador de documentos.
- 2 Ajuste la anchura de las guías de documentos según el tamaño del documento.
- 3 Introduzca el documento hasta que oiga un pitido.
- 4 Pulse **START/SET/COPY**.
- 5 Introduzca el número de copias.
- 6 Pulse **START/SET/COPY**.

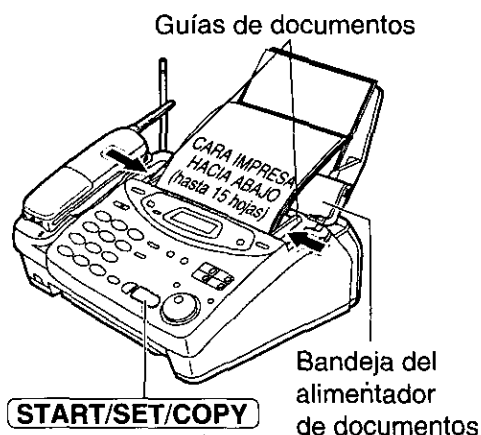

Index

- A** Accessories15, 16
 - Advanced features126, 127
 - (Resetting)110
 - Answering machine73–75
 - Any key talk feature35
 - Area code50
 - AUTO ANSWER button68, 71, 80
 - AUTO ANSWER mode68, 71, 80
 - AUTO button39
 - Auto disconnection85
 - Automatic dialing mode setting24
- B** Basic features126
 - Battery
 - (Charging)30
 - (Life)30
 - (Replacing)103
 - Belt clip31
 - BROADCAST keys64–66
 - Broadcast report66, 109
- C** Caller ID46
 - Caller ID list51, 109
 - CALLER ID SEARCH button47–49
 - CH button33
 - Character table27
 - Cleaning106–108
 - COLLATE button88
 - Communication messages90
 - Connecting tone67
 - Connections6, 24
 - Copy
 - (Collated)88
 - (Enlargement/reduction)88, 89
 - (Multiple copies)88
 - COPY button11, 88
- D** Date and time25
 - Delayed transmission62
 - Dialing mode38
 - DIRECT button40
 - Directory feature43, 45, 55, 64
 - DIRECTORY
 - PROGRAM button41, 43, 44, 64
 - Display
 - (Contrast)110
 - (Error messages)91, 92
 - Distinctive Ring service76, 77
 - Document feeder cleaning106
 - Document jam101
 - Document size59, 115
- E** Enlarge/Reduce copy88, 89
 - Error messages90–92
 - Extension telephone79, 82
- F** Facsimile telephone number28
 - FAX button10, 70
 - Fax activation code82
 - Fax auto redial54
 - FAX ONLY mode68, 71, 72
 - FAX ONLY ring count72
 - Fax pager86
 - Feature list109
 - Feeder cleaning106
 - Feeder jam102
 - Feeder pressure102
 - Film cartridge104, 105
 - Film detection87
 - FLASH button37
 - Friendly reception70, 85
- H** HANDSET/LOCATOR button35
 - Handset volume32
 - Headset31
 - HELP button17
 - HYPHEN key27, 41
- I** Ink film104, 105
 - INSERT key26, 27
 - IQ-FAX56–58
 - IQ-FAX button58
- J** Jam99–102
 - JOG DIAL
 - (Making a voice call)45
 - (Selecting characters)27
 - (Sending faxes)55
 - (Storing)43, 44
 - Journal auto print61
 - Journal report61, 109
- L** List
 - (Broadcast)66, 109
 - (Caller ID)51, 109
 - (Feature)109
 - (Journal)61, 109
 - (Printer test)109
 - (Sending)60
 - (Telephone number)109Location panel
 - (Handset)29
 - (Main unit)18, 19Logo26, 27
 - LOUD/RINGER button32
 - LOWER key41, 42, 54
- M** Memory reception alert70, 84
 - Memory transmission63
 - MONITOR button34, 52
 - Monitor volume32

- N** NAME/TEL NO. key45, 46
- O** One-Touch Dial
 - (Making a voice call)42
 - (Sending faxes)54
 - (Storing)41
- Other size documents83
- Overseas transmission mode67
- Overview20
- P** Pager call86
- Paper jam99, 100
- Paper stacker21, 22
- Paper tray5, 21
- PAUSE button37
- Power down report98
- Power failure98
- Power supply/cord6, 24, 115
- Printing paper size115
- Printing reports109
- Problem solving93–97
- PROGRAM button39, 40
- Programmable features126, 127
- Pulse38
- Q** QUICK SCAN button63, 88
- R** Receiving
 - (Fax)10, 70
 - (Setting)68, 69
- Receiving reduction83
- Recording paper5, 22, 23, 115
- Recording paper jam99, 100
- REDIAL button
 - (Handset)33, 36
 - (Main unit)34, 53
- Remote activation ID75
- Remote monitor36
- REMOTE SP button36
- Report
 - (Broadcast)66, 109
 - (Caller ID)51, 109
 - (Feature)109
 - (Journal)61, 109
 - (Printer test)109
 - (Sending)60
 - (Telephone number)109
- Reset110
- RESOLUTION button53
- Ring count
 - (FAX ONLY)72
 - (Silent fax recognition)81
 - (TEL/FAX)81
- Ring pattern detection76, 77
- Ringer volume
 - (Handset)32
 - (Main unit)32
- S** SECRET key41, 43
- Sending
 - (Broadcast)64–66
 - (From memory)63
 - (IQ-FAX)56–58
 - (JOG DIAL)55
 - (Manually)9, 53
 - (One-Touch Dial)54
- Sending document (Does not feed or multi-feeds)102
- Sending jam101
- Sending report60
- Set default110
- Silent detection84
- Silent fax recognition ring81
- Specifications115
- Storing
 - (Broadcast)64
 - (From the Caller ID list)51
 - (DIRECT button)40
 - (Handset)39
 - (JOG DIAL)43, 44
 - (One-Touch Dial)41
- T** TALK button33, 35
- TEL mode68, 70
- TEL/FAX delayed ring count81
- TEL/FAX mode78–81
- Telephone line cord6, 24
- Telephone number list109
- Thermal head cleaning107
- Tone38
- TONE button37
- Transmission
 - (Broadcast)64–66
 - (From memory)63
 - (IQ-FAX)56–58
 - (JOG DIAL)55
 - (Manually)9, 53
 - (One-Touch Dial)54
- Transmittable document59, 115
- V** Voice call
 - (Answering)8, 35
 - (JOG DIAL)45
 - (Making)7, 33, 34
 - (One-Touch Dial)42
- Voice contact52
- VOLUME button32

Features Summary

Summary of user programmable features

Basic features

Code	Feature & Display	Available settings	Meaning	Page
#01	Setting the date and time <input type="text" value="SET DATE & TIME"/>	(2 digits for each entry)	mm/dd/yy hh:mm	25
#02	Setting your logo <input type="text" value="YOUR LOGO"/>	(Up to 30 characters)		26
#03	Setting your facsimile telephone number <input type="text" value="YOUR FAX NO."/>	(Up to 20 digits)		28
#04	Printing the sending report <input type="text" value="SENDING REPORT"/>	ERROR	If transmission fails	60
		ON	Activate	
		OFF	Deactivate	
#06	Setting the ring count in the FAX ONLY mode <input type="text" value="FAX RING COUNT"/>	1, 2, 3, 4, 5 EXT.TAM	1 to 5 rings (5 rings for use with an answering machine)	72
#12	Securing the remote operation for the answering machine <input type="text" value="REMOTE TAM ACT."/>	ON / ID=11	Activate	75
		OFF	Deactivate	
#13	Setting the dialing mode <input type="text" value="DIALING MODE"/>	AUTO	Sets the dialing mode automatically.	38
		TONE	Sets to TONE.	
		PULSE	Sets to PULSE.	
#18	Checking the amount of remaining film <input type="text" value="FILM REMAIN"/>			104

(The pre-selected setting is in bold.)

Note:

- You can display basic features in the order above by rotating instead of entering the code number (#01, #02, etc.).

Advanced features

Code	Feature & Display	Available settings	Meaning	Page
#22	Setting the journal report to print automatically <input type="text" value="AUTO JOURNAL"/>	ON	Activate	61
		OFF	Deactivate	
#23	Sending documents overseas <input type="text" value="OVERSEAS MODE"/>	ON	Activate	67
		OFF	Deactivate	
#25	Sending a fax at a specified time <input type="text" value="DELAYED SEND"/>	ON	Activate	62
		OFF	Deactivate	
#26	Setting the Caller ID list to print automatically <input type="text" value="AUTO CALL. LIST"/>	ON	Activate	51
		OFF	Deactivate	

Features Summary

Code	Feature & Display	Available settings	Meaning	Page
#30	Setting the silent fax recognition ring count SILENT FAX RING	3 , 4, 5, 6	3 to 6 rings	81
#31	Setting the Distinctive Ring pattern RING DETECTION	A, B, C, D OFF	Patterns A-D Deactivate	77
#36	Receiving other sizes of documents RCV REDUCTION	100% 92% 86% 72%	Deactivate reduction 92% reduction 86% reduction 72% reduction	83
#39	Changing the display contrast LCD CONTRAST	NORMAL DARKER	Normal contrast Darker contrast	110
#40	Setting the silent detection SILENT DETECT.	ON OFF	Activate Deactivate	84
#41	Changing the fax activation code FAX ACTIVATION	ON / CODE= * 9 OFF	Activate Deactivate	82
#44	Setting the memory reception alert RECEIVE ALERT	ON OFF	Activate Deactivate	84
#46	Setting the friendly reception FRIENDLY RCV	ON OFF	Activate Deactivate	85
#49	Setting the auto disconnection AUTO DISCONNECT	ON / CODE= * 0 OFF	Activate Deactivate	85
#70	Signaling your pager when your unit receives a fax FAX PAGER CALL	ON OFF	Activate Deactivate	86
#75	Setting the IQ-FAX function IQ-FAX	ON OFF	Activate Deactivate	57
#76	Setting the connecting tone CONNECTING TONE	ON OFF	Activate Deactivate	67
#77	Changing the AUTO ANSWER setting AUTO ANSWER	FAX ONLY TEL/FAX	Facsimile only mode Telephone/Facsimile mode	80
#78	Setting the TEL/FAX delayed ring count TEL/FAX RING	1 , 2, 3, 4	1 to 4 rings	81
#79	Setting the film detection FILM DETECTION	ON OFF	Activate Deactivate	87
#80	Resetting the advanced features SET DEFAULT	YES NO	Reset Will not reset.	110

(The pre-selected setting is in bold.)

Panasonic FAX ADVANTAGE PROGRAM

**Free peace of mind,
direct from Panasonic**

NO EXTRA COST



- **1-year limited warranty¹ parts & labor**
- **Toll-free help line**
- **Free overnight replacement² and repair program**

The Panasonic Fax Advantage Consumer Service Program.

Panasonic knows that if your fax machine is not up and running, neither is your business. That's why we created the Panasonic Fax Advantage Program. Included at no extra cost with the purchase of a Panasonic Fax Machine, the Fax Advantage Program can provide a free replacement unit² overnight if your original unit is in need of repair.

Here's how it works:

1. If you have a problem with your fax while it is covered by the one-year limited warranty¹, call our toll-free help-line at 1-800-HELPFAX.
2. Talk to one of our technical experts to diagnose your problem over the phone.
3. If repairs are necessary and you are entitled to service under the terms and conditions of the limited warranty³, we will send a refurbished replacement unit to you overnight or second business day delivery, depending on the time of your call.

A second option available under our one-year limited warranty is to mail-in or carry-in your fax to one of our Regional Service centers, where the unit will be repaired and returned to you.

Instructions

If you choose to receive a replacement unit under the Fax Advantage Program, Panasonic will provide a replacement unit which will be completely refurbished, quality-tested by Panasonic technicians and individually hand-inspected before it is shipped to you. You will keep the replacement unit and send the original unit to us in the replacement unit's box. UPS will pick up the unit at no charge to you, should it be determined that you are entitled to warranty service. A proof-of-purchase must be included with the returned product. Any unit that is replaced by Panasonic and not shipped with proper proof-of-purchase by you will be subject to a minimum \$100.00 charge. The original unit must be properly packaged in the same manner as the replacement unit, utilizing

the packing materials provided. Damage due to improper or inadequate packing will be charged to you as an out-of-warranty cost. If our 1-800-HELPFAX technicians determine that your unit may be an "out-of-box failure"⁴, we will attempt to provide you with a factory-new replacement unit⁵. You must ship a copy of your receipt with your original unit to verify that you purchased the unit within 10 days prior to your 1-800-HELPFAX call.

Requirements

You must give our technicians a valid credit card number (Discover, VISA, Master Card, or American Express/Optima). Product that is not returned to Panasonic by 10 business days after shipment of the replacement product will be charged to your credit card account at Panasonic's Suggested Retail Price (see dealer for details). If your original unit is not eligible for warranty service, your card will be charged for the non-warranty repair of the unit at Panasonic's current rate for parts and labor and for any shipping charges associated with this program. If you do not wish to pay out-of-warranty repair costs, you will be responsible for returning the replacement unit to Panasonic and for paying all shipping charges associated with this program including the overnight delivery of the replacement product to you, shipment of the problem unit to Panasonic, shipment of the replacement unit back to Panasonic and the return of your original unit back to you. Credit status will be verified prior to sending the replacement product.

1. See dealer for limited warranty details.
2. Replacement unit is refurbished.
3. Replacement program excludes Puerto Rico and is subject to termination at any time without advance notice.
4. "Out-of-box failure" is an inoperable unit that was purchased no more than 10 days prior to your 1-800-HELPFAX call, and would otherwise qualify for warranty service under the terms and conditions of the limited warranty.
5. Panasonic reserves the right to send a refurbished unit.

Panasonic Consumer Electronics
Company, Division of Matsushita
Electric Corporation of America
One Panasonic Way, Secaucus,
New Jersey 07094

Panasonic Sales Company,
Division of Matsushita Electric of
Puerto Rico, Inc. ("PSC")
Ave. 65 de Infantería, Km. 9.5
San Gabriel Industrial Park, Carolina,
Puerto Rico 00985